

Lucent Technologies
Bell Labs Innovations



Lucent Intuity™

Release 3

Conversion to MERLIN LEGEND® and
MERLIN MAGIX™ Integrations

Comcode 108762121
Issue 1
June 2000

Notice

Every effort was made to ensure that the information in this book was complete and accurate at the time of printing. However, information is subject to change.

Preventing Toll Fraud

“Toll fraud” is the unauthorized use of your telecommunications system by an unauthorized party (for example, a person who is not a corporate employee, agent, subcontractor, or working on your company’s behalf). Be aware that there may be a risk of toll fraud associated with your system and that, if toll fraud occurs, it can result in substantial additional charges for your telecommunications services.

Lucent Technologies Fraud Intervention:

If you suspect *that you are being victimized* by toll fraud and you need technical assistance or support, call the Technical Service Center’s Toll Fraud Intervention Hotline at 1-800-643-2353.

Providing Telecommunications Security

Telecommunications security (of voice, data, and/or video communications) is the prevention of any type of intrusion to (that is, either unauthorized or malicious access to or use of your company’s telecommunications equipment) by some party.

Your company’s “telecommunications equipment” includes both this Lucent product and any other voice/data/video equipment that could be accessed via this Lucent product (that is, “networked equipment”). An “outside party” is anyone who is not a corporate employee, agent, subcontractor, or working on your company’s behalf. Whereas, a “malicious party” is anyone (including someone who may be otherwise authorized) who accesses your telecommunications equipment with either malicious or mischievous intent.

Such intrusions may be either to/through synchronous (time-multiplexed and/or circuit-based) or asynchronous (character-, message-, or packet-based) equipment or interfaces for reasons of:

- Utilization (of capabilities special to the accessed equipment)
- Theft (such as, of intellectual property, financial assets, or toll-facility access)
- Eavesdropping (privacy invasions to humans)
- Mischief (troubling, but apparently innocuous, tampering)
- Harm (such as harmful tampering, data loss or alteration, regardless of motive or intent)

Be aware that there may be a risk of unauthorized intrusions associated with your system and/or its networked equipment. Also realize that, if such an intrusion should occur, it could result in a variety of losses to your company (including but not limited to, human/data privacy, intellectual property, material assets, financial resources, labor costs, and/or legal costs).

Your Responsibility for Your Company’s Telecommunications Security

The final responsibility for securing both this system and its networked equipment rests with you – a Lucent customer’s system administrator, your telecommunications peers, and your managers. Base the fulfillment of your responsibility on acquired knowledge and resources from a variety of sources including but not limited to:

- Installation documents
- System administration documents
- Security documents
- Hardware-/software-based security tools
- Shared information between you and your peers
- Telecommunications security experts

To prevent intrusions to your telecommunications equipment, you and your peers should carefully program and configure your:

- Lucent-provided telecommunications systems and their interfaces
- Lucent-provided software applications, as well as their underlying hardware/software platforms and interfaces

- Any other equipment networked to your Lucent products. Lucent Technologies does not warrant that this product or any of its networked equipment is either immune from or will prevent either unauthorized or malicious intrusions. Lucent Technologies will not be responsible for any charges, losses, or damages that result from such intrusions.

Federal Communications Commission Statement

Part 15: Class A Statement. This equipment has been tested and found to comply with the limits for a Class A digital device, pursuant to Part 15 of the FCC Rules. These limits are designed to provide reasonable protection against harmful interference when the equipment is operated in a commercial environment. This equipment generates, uses, and can radiate radio-frequency energy and, if not installed and used in accordance with the instruction manual, may cause harmful interference to radio communications. Operation of this equipment in a residential area is likely to cause harmful interference, in which case the user will be required to correct the interference at his/her own expense.

Part 15: Personal Computer Statement. This equipment has been certified to comply with the limits for a Class B computing device, pursuant to Subpart J of Part 15 of FCC Rules. Only peripherals (computing input/output devices, terminals, printers, etc.) certified to comply with the Class B limits may be attached to this computer. Operation with noncertified peripherals is likely to result in interference to radio and television reception.

Part 68: Network Registration Number. This equipment is registered with the FCC in accordance with Part 68 of the FCC Rules. It is identified by FCC registration number AS5USA-20411-VM-E.

Part 68: Answer-Supervision Signaling. Allowing this equipment to be operated in a manner that does not provide proper answer-supervision signaling is in violation of Part 68 rules. This equipment returns answer-supervision signals to the public switched network when:

- Answered by the called station
- Answered by the attendant
- Routed to a recorded announcement that can be administered by the CPE user

This equipment returns answer-supervision signals on all DID calls forwarded back to the public switched telephone network. Permissible exceptions are:

- A call is unanswered
- A busy tone is received
- A reorder tone is received

Canadian Department of Communications (DOC)

Interference Information

This digital apparatus does not exceed the Class A limits for radio noise emissions set out in the radio interference regulations of the Canadian Department of Communications.

Le Présent Appareil Numérique n’émet pas de bruits radioélectriques dépassant les limites applicables aux appareils numériques de la class A prescrites dans le règlement sur le brouillage radioélectrique édicté par le ministère des Communications du Canada.

Lucent Technologies Fraud Intervention

If you suspect that you are being victimized by toll fraud and you need technical support or assistance, call BCS Technical Service Center Toll Fraud Intervention Hotline at 1 800 643-2353.

European Union Declaration of Conformity

Lucent Technologies Business Communications Systems declares that the equipment specified in this document conforms to the referenced European Union (EU) Directives and Harmonized Standards listed below:

EMC Directive 89/336/EEC

Low-Voltage Directive 73/23/EEC



The “CE” mark affixed to the equipment means that it conforms to the above directives.

Contents

About This Document	vii
■ Overview	vii
■ Intended Audience	vii
■ How this Document Is Organized	vii
■ Conventions Used	viii
■ Related Resources	ix
■ Trademarks and Service Marks	xi
■ Training	xii
■ How to Make Comments About this Document	xii

Conversion Checklist	1-1
■ Overview	1-1
■ Conversion Checklist	1-2

Conversion Instructions	2-1
■ Overview	2-1
■ How to Use Lucent INTUITY Screens	2-2
■ Conversion Procedures	2-2
Task 1: Inventory Materials	2-3
Task 2: Deactivate Alarm Origination	2-3
Task 3: Stop the Voice System	2-5
Task 4: Make an Attended Back-up Tape	2-6
Task 5: Remove the Previous Switch Integration Software	2-10
Task 6: Shutdown the System	2-12
Task 7: Remove Hardware for the Previous Integration	2-13
MAP/5 Instructions	2-13
MAP/5: Remove the Front Panel	2-13
MAP/5: Remove the Top Cover	2-15
MAP/5: Locate and Remove the GP Synch or DCIU Circuit Card	2-17
MAP/5: Replace the Top Cover and Cables	2-18
MAP/40 Instructions	2-19
MAP/40: Open the MAP	2-19

Contents

MAP/40: Locate and Remove the GP Synch or DCIU Circuit Card	2-23
MAP/40: Replace the Cover and Cables	2-24
MAP/100 Instructions	2-25
MAP/100: Open the MAP	2-25
MAP/100: Locate and Remove the GP Synch or DCIU Circuit Card	2-26
MAP/100: Replace the Covers and Cables	2-27
Task 8: Allow the System to Finish Booting	2-28
Task 9: Install the MERLIN LEGEND Switch Integration Software	2-29
Stop the Voice System	2-29
Install the MERLIN LEGEND Switch Integration Software	2-30
Start the Voice System	2-32
Task 10: Administer the Lucent INTUITY System for Operation with the MERLIN LEGEND	2-32
Task 11: Shutdown the Lucent INTUITY System	2-33
Task 12: Cable the MAP and Administer the MERLIN LEGEND Communications System	2-34
Task 13: Apply Power to the System	2-34
Task 14: Test the Channels if the Mapping Changed	2-35
Task 15: Change the CAS Switch Assignment	2-36
Task 16: Clear any Alarms	2-37
Task 17: Place Test Calls to the System	2-38
Task 18: Assign the System Date and Time	2-38
Task 19: Stop the Voice System	2-40
Task 20: Back Up the System-Data	2-41
Task 21: Start the Voice System	2-41
Task 22: Activate Alarm Origination	2-42
Task 23: Create a Test Alarm	2-45
Task 24: Replace the Nightly Backup Tape	2-47
Task 25: Remove the Old Software from the Site	2-47

Channel Mapping	A-1
■ Overview	A-1
■ Administer the INTUITY Switch Interface	A-1
■ Map Channels to Switch Extensions	A-1
■ Verify Channel State	A-4
■ Assign Service to Channels for Testing	A-8

Contents

- Test Each Channel A-10
- Assign Services to Called Numbers A-13
- Map Services to Channels for Operation A-17

Using the Change Extensions Command

- Overview B-1
- Busyout the Voice Ports B-2
- Busyout the Networking Ports B-3
- Stop the Voice System B-5
- Changing a Block of Extensions
(with Extension Length Change) B-6
- Changing a Block of Extensions (without Extension Length Change) B-9
- Release the Voice Ports B-12
- Release the Networking Ports B-14



Contents

About This Document

Overview

This document, *Lucent Intuity™ Release 3 Switch Conversion to MERLIN LEGEND or MERLIN MAGIX Integrations*, Issue 1, contains the procedures needed to move a Release 3 Lucent INTUITY system to a MERLIN LEGEND® or MERLIN MAGIX™ integration from any other switch integration type.

Intended Audience

This document is intended for on-site technicians and remote maintenance center personnel supporting an INTUITY switch conversion.

How this Document Is Organized

This document is organized in the following chapters:

- Chapter 1, "Conversion Checklist"
This chapter presents a checklist of procedures needed to convert Lucent INTUITY Release 3 Systems to MERLIN LEGEND or MERLIN MAGIX Integrations.
- Chapter 2, "Conversion Instructions"
This chapter presents the procedures needed to convert Lucent INTUITY Release 3 Systems to MERLIN LEGEND or MERLIN MAGIX Integrations.
- Appendix A, "Channel Mapping"
This appendix presents the information necessary to perform channel mapping and acceptance testing.

-
- Appendix B, “Using the Change Extensions Command”

This appendix presents the information necessary to move a series of extension numbers from one block of numbers to another without changing each number individually.

Conventions Used

The following conventions are used in this document:

- Rounded boxes represent keyboard keys that you press.
For example, an instruction to press the enter key is shown as
Press **ENTER**.
- Square boxes represent phone pad keys that you press.
For example, an instruction to press zero on the phone pad is shown as
Press **0**.
- The word “enter” means to type a value and press **ENTER**.
For example, an instruction to type y and press **ENTER** is shown as
Enter **y** to continue.
- Two or three keys that you press at the same time (that is, you hold down the first key while pressing the second and/or third key) are shown as a rounded box that contains two or more words separated by hyphens. For example, an instruction to press and hold **ALT** while typing the letter d is shown as
Press **ALT-d**.
- Commands and text you type or enter appear in **bold**.
- Values, instructions, and prompts that you see on the screen appear as follows: `Press any key to continue.`
- Variables that the system supplies or that you must supply appear in *italics*.
For example, an error message including one of your filenames appears as
The file *filename* is formatted incorrectly

Related Resources

In addition to this document, you may need to reference the following documents:

Document	Document Number	Issue
<i>INTUITY™ Release 3.0 System Description</i>	585-310-232	1 or later
<i>INTUITY™ Documentation Guide</i>	585-310-540	2 or later
<i>INTUITY™ New System Planning for Release 3.0</i>	585-310-605	2 or later
<i>INTUITY™ Release 3.0 Planning for Upgrades</i>	585-310-653	1 or later
<i>INTUITY™ Release 3.0 Planning for Migrations</i>	585-310-652	1 or later
<i>INTUITY™ Installation Checklist</i>	585-310-161	2 or later
<i>INTUITY™ MAP/5 Hardware Installation</i>	585-310-146	2 or later
<i>INTUITY™ MAP/40 Hardware Installation</i>	585-310-138	2 or later
<i>INTUITY™ MAP/100 Hardware Installation</i>	585-310-139	2 or later
<i>INTUITY™ Software Installation for Release 3.0</i>	585-310-160	2 or later
<i>INTUITY™ Release 3.0 Upgrade Procedures</i>	585-310-164	2 or later
<i>INTUITY™ Release 3.0 Migration Procedures</i>	585-310-233	2 or later
<i>INTUITY™ Platform Administration and Maintenance for Release 3.0</i>	585-310-557	2 or later
<i>INTUITY™ AUDIX® Release 3.3 Administration and Feature Operations</i>	585-310-552	3 or later
<i>INTUITY™ FAX Messaging Administration and Addenda</i>	585-310-558	1 or later
<i>INTUITY™ AUDIX® Digital Networking Administration</i>	585-310-533	2 or later
<i>AMIS Analog Networking</i>	585-300-512	6 or later
<i>INTUITY™ Lodging Administration and Feature Operations</i>	585-310-559	1 or later
<i>INTUITY™ Lodging Property Management System Specifications</i>	585-310-234	1 or later
<i>INTUITY™ Call Accounting System User Guide</i>	585-310-728	1 or later
<i>INTUITY™ Call Accounting System Quick Reference</i>	585-310-729	1 or later
<i>INTUITY™ Intro Voice Response and Addenda</i>	585-310-716	1 or later
<i>INTUITY™ Message Manager Release 4 User's Guide</i>	585-310-743	1 or later
<i>INTUITY™ Message Manager Release 4.1: Getting Started (Available late 1996)</i>	585-310-740	1 or later
<i>AUDIX® Administration and Data Acquisition Package</i>	585-310-502	4 or later

<i>INTUITY™ Integration with System 75 and DEFINITY® Communications System Generic 1 and Generic 3</i>	585-310-214	4 or later
<i>INTUITY™ Integration with System 85 and DEFINITY® Communications System Generic 2</i>	585-310-215	2 or later
<i>INTUITY™ Integration with MERLIN LEGEND® Communications System</i>	585-310-255	1 or later
<i>INTUITY™ Integration with the 5ESS® Switch</i>	585-310-219	1 or later
<i>INTUITY™ Integration with DMS-100</i>	585-310-223	1 or later
<i>INTUITY™ Integration with Northern Telecom® SL-1, Meridian™, and Meridian SL-1</i>	585-310-221	2 or later
<i>INTUITY™ Integration with Mitel™ SX-200® DIGITAL, SX-100®, and SX-200®</i>	585-310-222	2 or later
<i>INTUITY™ Integration with NEC® NEAX™</i>	585-310-216	2 or later
<i>INTUITY™ Integration with ROLM™ 8000, 9000, 9571</i>	585-310-220	2 or later
<i>INTUITY™ Lodging Artwork Package</i>	585-310-739	1 or later
<i>Voice Messaging Quick Reference</i>	585-300-702	3 or later
<i>A Portable Guide to Voice Messaging</i>	585-300-701	3 or later
<i>INTUITY™ Voice/FAX Messaging Quick Reference</i>	585-310-734	1 or later
<i>INTUITY™ Voice/FAX User Guide</i>	585-310-733	1 or later
<i>Multiple Personal Greetings Quick Reference</i>	585-300-705	5 or later
<i>Voice Messaging Wallet Card</i>	585-304-704	2 or later
<i>Voice Messaging Outcalling Quick Reference</i>	585-300-706	1 or later
<i>Voice Messaging Business Card Stickers</i>	585-304-705	2 or later
<i>INTUITY™ AUDIX® R3.3 Voice Messaging Subscriber Artwork Package</i>	585-310-735	1 or later
<i>INTUITY™ AUDIX® R3.3 Voice/Fax Messaging Quick Reference—Canadian French</i>	585-310-734FRC	1 or later
<i>INTUITY™ AUDIX® R3.3 Voice/Fax Messaging Quick Reference—British English</i>	585-310-734ENB	1 or later
<i>INTUITY™ AUDIX R3.3® Voice/Fax Messaging Quick Reference—Latin Spanish</i>	585-310-734SPL	1 or later
<i>INTUITY™ AUDIX R3.3® Voice/Fax Messaging Quick Reference—Greek</i>	585-310-734GK	1 or later
<i>INTUITY™ AUDIX R3.3® Voice/Fax Messaging Quick Reference—Mandarin</i>	585-310-734CHM	1 or later

<i>INTUITY™ Lodging Subscriber Artwork Package British English</i>	585-310-739ENB	1 or later
<i>INTUITY™ Lodging Artwork Package Canadian French</i>	585-310-739FRC	1 or later
<i>INTUITY™ Lodging Artwork Package Latin Spanish</i>	585-310-739SPL	1 or later
<i>INTUITY™ Lodging Artwork Package Greek</i>	585-310-739GK	1 or later
<i>INTUITY™ Lodging Artwork Package Mandarin</i>	585-310-739CHM	1 or later
<i>INTUITY™ Lodging Artwork Package Japanese</i>	585-310-739JA	1 or later
<i>INTUITY™ Lodging Artwork Package U.S. English (A4 Sizing)</i>	585-310-739A4	1 or later

Trademarks and Service Marks

The following trademarked products are mentioned in the books in the INTUITY library:

- AT™ is a trademark of Hayes Microcomputer Products, Inc.
- AUDIX® is a registered trademark of Lucent Technologies, Inc.
- COMSPHERE® is a registered trademark of Lucent Technologies Paradyne Corp.
- DEFINITY® is a registered trademark of Lucent Technologies, Inc., in the U.S. and throughout the world.
- Equinox™ is a trademark of Equinox Systems, Inc.
- 5ESS® is a registered trademark of Lucent Technologies, Inc.
- INTUITY™ is a trademark of Lucent Technologies, Inc.
- MEGAPLEX™ is a trademark of Equinox System, Inc.
- MEGAPORT™ is a trademark of Equinox Systems, Inc.
- MERLIN LEGEND® is a registered trademark of Lucent Technologies, Inc.
- Microsoft® is a registered trademark of Microsoft Corporation.
- Paradyne® is a registered trademark of Lucent Technologies, Inc.
- Phillips® is a registered trademark of Phillips Screw Company.
- softFAX® is a registered trademark of VOXEM, Inc.
- TMI™ is a trademark of Texas Micro Systems, Inc.
- UNIX® is a registered trademark of Novell in the United States and other countries, licensed exclusively through X/Open Company Limited.
- VOXEM® is a registered trademark of VOXEM, Inc.
- VT100™ is a trademark of Digital Equipment Corporation.

Training

For more information on training for the Lucent INTUITY and other Lucent products, visit the Lucent Technologies training web site at www.lucenttraining.com.

How to Make Comments About this Document

We are interested in your suggestions for improving this book. Please complete and return the reader comment card that is located at the back of the book. You can use any of your favorite mail methods:

Post Office:

Lucent Technologies
Communications Applications Group, Technical Publications
Room 22-2H15
11900 North Pecos Street
Denver, Colorado 80234

Email: octeltechpubs@lucent.com

Fax or voice mail: +303-538-9625

Please be sure to mention the name and order number of this book.

Conversion Checklist

1

Overview

This chapter contains a checklist of procedures needed to convert Lucent Intuity Release 3 Systems to MERLIN LEGEND® or MERLIN MAGIX™ integrations.

Conversion Checklist

Table 1-1 provides the checklist for Lucent INTUITY Release 3 System conversion to MERLIN LEGEND and MERLIN MAGIX Integrations.

Table 1-1. INTUITY Conversion to MERLIN LEGEND and MERLIN MAGIX Integrations

Task	Description	See	✓
1.	Inventory Materials	Page 2-3	
2.	Deactivate Alarm Origination	Page 2-3	
3.	Stop the Voice System	Page 2-5	
4.	Make an Attended Back-up Tape	Page 2-6	
5.	Remove the Previous Switch Integration Software	Page 2-10	
6.	Shutdown the System	Page 2-12	
7.	Remove Hardware for the Previous Integration	Page 2-13	
8.	Allow the System to Finish Booting	Page 2-28	
9.	Install the MERLIN LEGEND Switch Integration Software	Page 2-29	
10.	Administer the Lucent INTUITY System for Operation with the MERLIN LEGEND	Page 2-32	
11.	Shutdown the Lucent INTUITY System	Page 2-33	
12.	Cable the MAP and Administer the MERLIN LEGEND Communications System	Page 2-34	
13.	Apply Power to the System	Page 2-34	
14.	Test the Channels if the Mapping Changed	Page 2-35	
15.	Change the CAS Switch Assignment	Page 2-36	
16.	Clear any Alarms	Page 2-37	
17.	Place Test Calls to the System	Page 2-38	
18.	Assign the System Date and Time	Page 2-38	
19.	Stop the Voice System	Page 2-40	
20.	Back Up the System-Data	Page 2-41	
21.	Start the Voice System	Page 2-41	
22.	Activate Alarm Origination	Page 2-42	
23.	Create a Test Alarm	Page 2-45	
24.	Replace the Nightly Backup Tape	Page 2-47	
25.	Remove the Old Software from the Site	Page 2-47	

Conversion Instructions

2

Overview

This chapter contains procedures needed to convert Lucent Intuity Release 3 Systems to MERLIN LEGEND® or MERLIN MAGIX™ integrations.

How to Use Lucent INTUITY Screens

The INTUITY system is controlled by two methods: command entry from the INTUITY AUDIX screens and selection from the INTUITY system screens.

Two terms are used in the directions:

- Select
- Enter

Select

This document will instruct you to “select” certain options.

To select:

1. Highlight the choice that you want. To highlight a choice, use the up and/or down arrow keys.
2. Press **ENTER** with the choice highlighted.

The system displays the next screen or requests additional information.

To exit the screen or go back to the previous screen, press CANCEL, the F6 function key. The **F6** (Cancel) key will not stop any processes. Instead, it will exit the screen. Any information not saved (**F3** Save) will be lost.

To log out of the system, press the **F6** (Cancel) key until you reach the Console Login prompt.

Enter

To enter information, type in the information and press the ENTER key on the keyboard. For example, if the instruction is “Enter **3**” then:

1. Type the number **3**. The information to be typed in is shown in bold in the instruction.
2. Press **ENTER**. The enter key is located on the keyboard. It is not a function key.

Conversion Procedures

Follow the steps in these tasks in the exact order in which they appear. **Failure to follow the steps in this document in the exact order will result in a conversion failure.**

Task 1 - Inventory Materials

Verify that you have the following materials and information before starting the conversion:

- Conversion checklist from Chapter 1, "Conversion Checklist", page 1-2
- Login password for *craft*
- Remote maintenance center contact
- The document *INTUITY Integration with MERLIN LEGEND Communications System*, 585-310-255, Issue 1
- The completed worksheets from Chapter 2, "Planning the Integration", in *INTUITY Integration with MERLIN LEGEND Communications System*, 585-310-255, Issue 1



CAUTION:

Without the information from the worksheets, you will not be able to complete the installation.

- Switch integration software for MERLIN LEGEND integrations:
 - The MERLIN LEGEND switch integration floppies (J1P321TC1 L-27) (2-disks)
 - The SPM floppies (J1P321TC1 L-26)
 - Blank tape(s) for back-up



NOTE:

Do not use a tape size smaller than 525 Mbytes with the INTUITY system. Tapes smaller than 525 Mbytes cause the backup to fail. If the system has a 2-Gbyte tape drive, use either a 525 (406168526) or a 2-Gbyte (407333582) tape.

- Hardware: Any cables necessary to connect the Lucent INTUITY system to the MERLIN LEGEND Communications system.

Task 2 - Deactivate Alarm Origination

This procedure deactivates alarm origination so that the Lucent INTUITY system will not inform the remote maintenance center of any alarms that occur during the update process.



NOTE:

If the system does not have alarm origination, continue with Task 3, "Stop the Voice System", page 2-5.

To deactivate alarm origination:

-
1. Beginning at the Lucent INTUITY Administration menu, select:

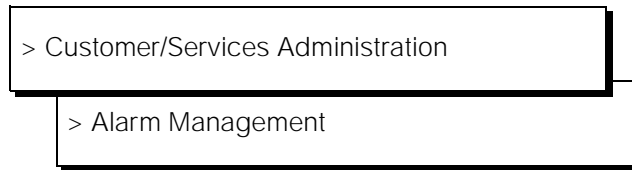

The system displays the Alarm Management screen (Figure 2-1).

Alarm Management	
Product ID	_____
Alarm Destination	_____
Alarm Origination	ACTIVE
Alarm Level	MINOR
Alarm Suppression	INACTIVE
Clear Alarm Notification	ACTIVE

Figure 2-1. Alarm Management Screen

2. Move the cursor to the Alarm Origination field.
3. Press **F2** (Choices).

The system displays the Alarm Origination screen (Figure 2-2).

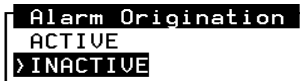

Figure 2-2. Alarm Origination Menu

4. Select INACTIVE.

The system changes the entry in the Alarm Origination field to INACTIVE.

5. Press **F3** (Save).

The system displays an Information screen (Figure 2-3).

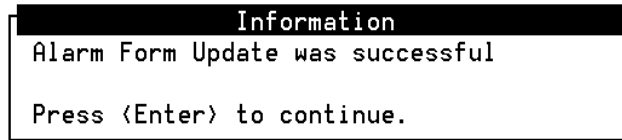

Figure 2-3. Information Screen

6. Press **ENTER**.
The system returns to the Alarm Management screen.
7. Press **F6** (Cancel) twice.
The system returns to the Customer/Services Administration screen.
8. Continue with Task 3, "Stop the Voice System".

Task 3 - Stop the Voice System

The following procedure describes how to stop the Lucent INTUITY voice system.

1. Starting at the Customer/Services Administration menu, select:

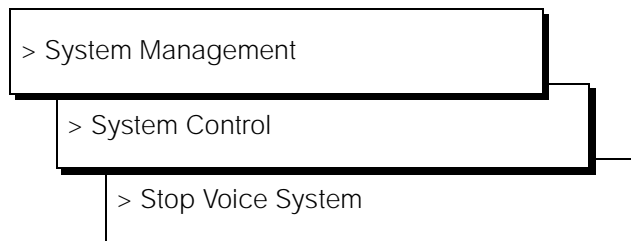

The system displays the following prompt:

Enter y to continue, n to quit.

2. Enter **y**
The system stops the voice system and returns to the System Control screen. If the system displays the following message:
The Voice System has stopped.
Press ENTER to continue . . .
press **ENTER** to return to the System Control screen.
3. Press **F6** (Cancel) twice to return to the Customer/Services Administration screen.
4. Continue with Task 4, "Make an Attended Back-up Tape".

Task 4 - Make an Attended Back-up Tape

This procedure creates a back-up tape that can contain the system data, AUDIX names, announcements, greetings, and messages for the Lucent INTUITY system. Verify with your remote maintenance center which information should be backed up for this customer.

⇒ NOTE:

Do not use a tape size smaller than 525 Mbytes with the Lucent INTUITY system. Tapes smaller than 525 Mbytes will cause the backup to fail. If the system is equipped with a 2-Gbyte tape drive, use either a 525 or a 2-Gbyte tape.

To make an attended backup tape:

1. Locate the tape drive.
 - On the MAP/5, the tape drive is located at the front of the system, to the right, behind the sliding door.
 - On the MAP/40, the tape drive is located on the front of the computer, near the top, under the top cover.
 - On the MAP/100, the tape drive is located inside the right door, near the top.
2. Remove the nightly backup tape:
 - If the tape is visible in the tape drive, press the tape in toward the tape drive and then release. This action will release the tape.
 - If the tape drive has a door that conceals the tape, press the small button on the upper right-hand corner of the tape drive to open the tape drive door. The tape will slide out as the door opens.
3. Store the nightly backup tape in a safe place. Do not place the tape near any magnetized components.
4. From the Customer/Services Administration screen, select:

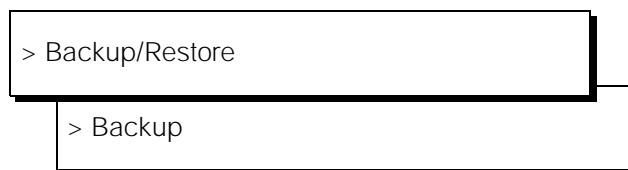

The system displays the Backup screen (Figure 2-4).

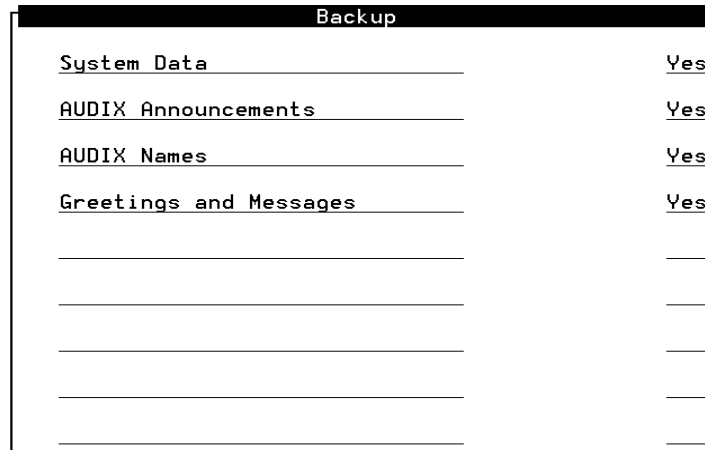

Figure 2-4. Backup Screen



NOTE:

The fields displayed on the Backup screen are based upon your system's configuration. Therefore, your screen may look different than Figure 2-4.

5. Go to the AUDIX Announcements field.
6. Press **F2** (Choices).

The system displays the Item 2 screen (Figure 2-5).

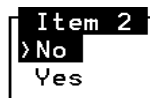

Figure 2-5. Item 2 Screen

7. Move the cursor to the No selection and press **ENTER**.

The system changes the AUDIX Announcements field to No.

8. Press **F3** (Save).

The system displays the following prompt:

****** calculating approximate number of tape(s) required****
please wait**

The backup will need approximate:

x 525 MB cartridge tape(s).

****verify whole backup tape(s) will double the amount of backup time
do you really want to verify tape(s)?
(strike y or n)**** n

x in the above message is the number of backup tapes that you will need.

9. Enter **y** Verify the backup.

The system displays the following messages:

please insert a cartridge tape into the tape drive to back up tape 1

press <Enter> when tape is inserted.

press <Esc> key to terminate the backup.

10. Insert a backup tape. Make sure that the tape is not set to "SAFE". The system will have one of two styles of tape drive:



CAUTION:

Do not use the nightly backup tape for this procedure.

- If the tape drive has a door that folds down:
 - a. If the drive door is closed, press the small button on the upper right-hand corner of the tape drive to open the door.
 - b. Insert the tape into the open drive. When inserted, the label of the tape should be up, and the opening to the tape should be to the right (Figure 2-6).
 - c. Close the door to the tape drive.

The system turns on the green light on the tape drive door.

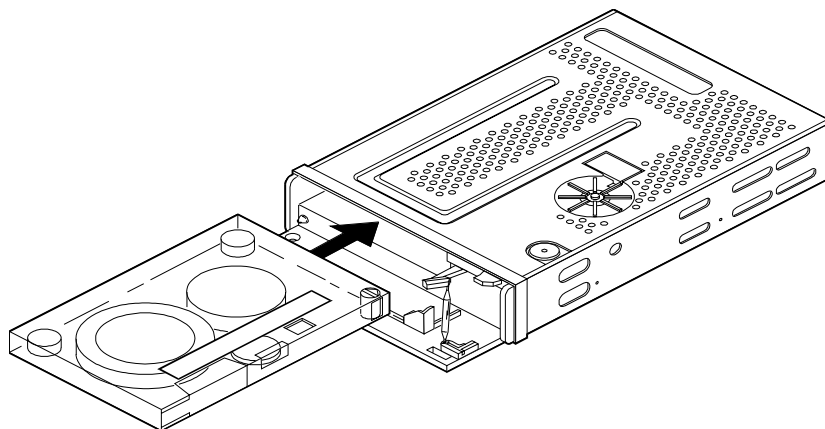

Figure 2-6. Inserting a Cartridge Tape Into An Outward-Hinged 2-Gbyte Tape Drive

- If the tape drive has a door that swings in toward the body of the tape drive (Figure 2-7):
 - a. Insert the tape label-side up, with the opening to the left.

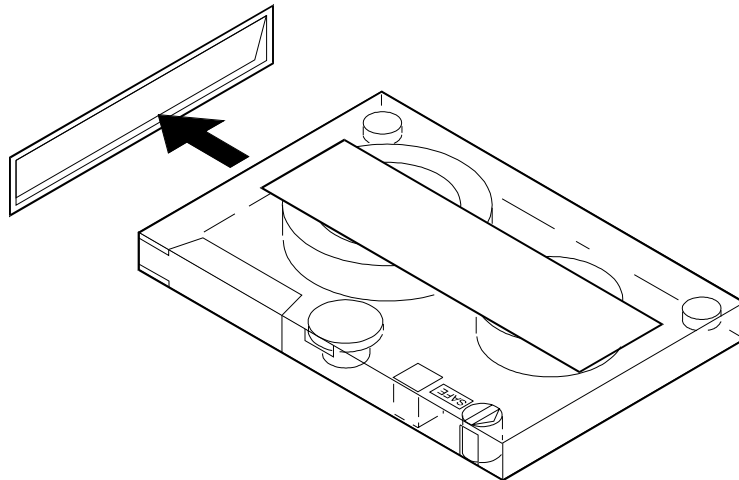

Figure 2-7. Inserting a Cartridge Tape Into An Inward-Hinged 525-Mbyte Tape Drive

- b. Press the tape firmly into place.
11. Press **[ENTER]**.

The system displays the following text:

```
**** tape 1 pre-process started ****
```
- ⇒ NOTE:**

The tape drive light stays on to indicate that the drive is in use.
12. Insert additional cartridge tapes if the system prompts you to do so.
- ⇒ NOTE:**

If the system requires more than 1 tape, label each additional cartridge tape after it is completed.
- The system will verify the backup(s).

The system finishes the attended backup and displays the following message:

```
backup process has been completed successfully  
press any key to continue
```
13. Press **[ENTER]**.
14. Remove the attended back-up tape from the tape drive.
15. Press **[F6]** (Cancel) twice to reach the Customer/Services Administration screen.

16. Continue with Task 5, "Remove the Previous Switch Integration Software".

Task 5 - Remove the Previous Switch Integration Software

Remove the previous switch integration software first from the Lucent INTUITY system.

1. Starting at the Customer/Services Administration screen, select:

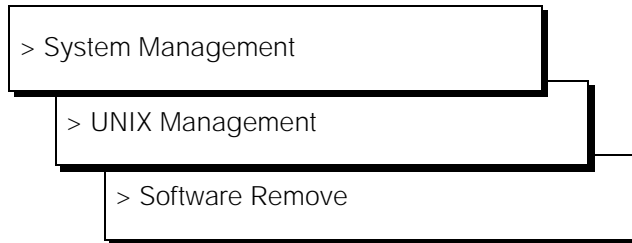

The system lists the software (Figure 2-8).



NOTE:

Your system configuration may be different from the example. Thus, this example screen display will not match your screen display.

```
1 DCIU          Intuity DCIU Link Software Set (U2)
                  (486) 3.1p-42
2 INTUNIX       UNIX SUR4.2 Enhancement Set - Update H
                  (486) Rel. 2 of Indep UNIX, USL SUR4.2.3
3 IVC6DI        AT&T Intuity IVC6 Device Interface for softFAX 2.0
                  (x86sur4_ints1) 2.0.07.31
4 OSmods        Intuity Operating System Modifications Module
                  (486) 3.0-55
5 RMBSET        Remote Maintenance Board Set for R3.3
                  (AUDIX) 3.3-55
6 UM            AUDIX(R) Module marker file
                  (AUDIX) NA
7 UM-dfltdb     AUDIX(R) Default db
                  (AUDIX) 3.3-55
8 UM-files      AUDIX(R) Files
                  (AUDIX) 3.3-55
9 UM-sw         AUDIX(R) Software
                  (AUDIX) 3.3-55
10 Uex          Intuity Application Software Set
                  (486) 3.0-55

.. 66 more menu choices to follow;
:RETURN> for more choices, <CTRL-D> to stop display:
```

Figure 2-8. Example Software Installed List

2. Locate the previous switch integration software package:

Table 2-1. Previous Switch Integration Software Package

Package Name	Integration Type
S25SWIN AAS	The following are S25SWIN packages: <ul style="list-style-type: none"> ■ INTUITY System 25 Switch Integration Package ■ AAS (System 25 Advanced Administration)
DCIU	INTUITY DCIU Link Software Set
smdi	INTUITY 5ESS Switch Integration Package

3. Using the numbers in the far left-hand column, note the list number of the package.
4. Press **CTRL-D**.

The system displays the following message:

**Select package(s) you wish to process (or 'all' to process all packages).
(default: all) [?,??,q]**

5. Enter the number of the package to be removed.



CAUTION:

*Remove **only one** package at a time. Removing multiple packages at one time could result in a conversion failure.*

The system displays the name and version number of the selected package.

6. Enter **y**

The system removes the package and may re-install files.



NOTE:

If you receive messages warning of dependencies, enter **y** to continue with the software removal.

7. Press **ENTER**.

The system displays the UNIX Management screen.

8. Press **F6** (Cancel) twice to return the Customer/Services Administration screen.

9. Determine your next step:

- If you have more packages to remove, such as the AAS package, go back to Step 1.
- If you do not have any more packages to remove, continue with Step 10.

-
10. Continue with Task 6, "Shutdown the System".

Task 6 - Shutdown the System

Shutdown the system to prepare it for hardware removal or a reboot. Not doing a reboot can lead to failure of the software installation.

1. Starting at the Customer/Services Administration screen, select:

> System Management

> System Control

> Shutdown Voice System

The system displays the following message:

Enter y to continue, no to quit

2. Enter **y** to continue the shutdown.

The system starts the shutdown, presents shutdown messages, and then displays the following message:

The system is down.

Press CTRL-ALT-DEL to reboot your computer.

3. Determine your next step:

- If the system has DCIU or GP Synch circuit card installed, continue with Task 7, "Remove Hardware for the Previous Integration".
- If the system does not have a DCIU or GP Synch circuit card installed, press the reset button or **CTRL-ALT-DELETE** to reboot the system.

If the system does not respond to **CTRL-ALT-DELETE**, press the reset button.

Continue with Task 8, "Allow the System to Finish Booting" on page 2-28.

Task 7 - Remove Hardware for the Previous Integration

If the system has a GP Synch or DCIU circuit card, remove it.

- For MAP/5 systems, start on page 2-13.
- For MAP/40 systems, start on page 2-19.
- For MAP/100 systems, start on page 2-25.

MAP/5 Instructions

For additional information about the MAP/5, see *INTUITY MAP/5 Hardware Installation*, 585-310-146.

MAP/5: Remove the Front Panel

You must remove the front panel before removing the top cover for access to the inside of the system. See Figure 2-9 and follow the steps below:

1. Turn off the front power switch and remove the incoming AC line.
2. Tag the power cord plugs with a note indicating that nobody other than yourself should reconnect power to this equipment.
3. Disconnect keyboard and monitor cords.
4. Disconnect the LAN cable and any cables that will restrict access to the system.
5. Slide the unit over the edge of the table toward you so that you can access the release tabs. Figure 2-9 shows the location of these tabs.



CAUTION:

Do not unbalance the unit so that it falls.

6. Push inward and upward on the two front panel latches to release the bottom edge of the front panel. See Figure 2-9.



NOTE:

The front panel is flexible enough for you to press one latch and then the other.

7. When the bottom of the front panel is loose, rotate the panel away from you and lift it to remove.
8. Return the unit to its correct desktop position.
9. Continue with the next step, "MAP/5: Remove the Top Cover".

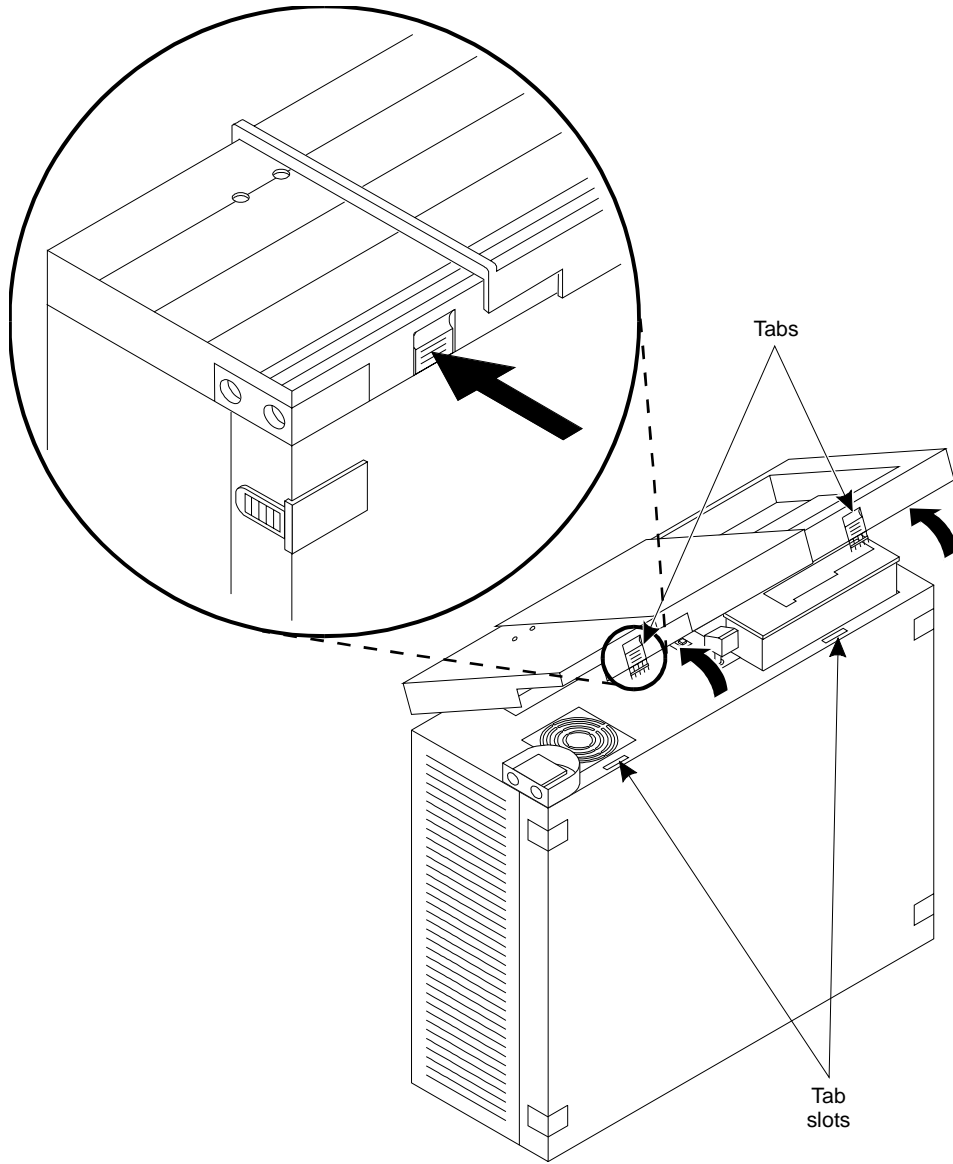

Figure 2-9. Removing the MAP/5 Front Panel

MAP/5: Remove the Top Cover

This procedure assumes that you have already removed the front panel. See Figure 2-10.

1. Unlock the system unit by inserting the key in the lock and turning it counter-clockwise to the unlocked position.

The case lock is located in the top center of the front of the unit. Keys are included with the system. The case lock must be in the open position to remove the top cover.

2. Press the holding tabs outward while pushing the top cover away from you. See Figure 2-10.

The locking tabs are located on either side of the front of the unit.

3. Slide the top cover as far back as it will go, which is about 1/2-inch.
4. Lift the top cover straight up to remove.
5. Continue with "MAP/5: Locate and Remove the GP Synch or DCIU Circuit Card" on the next page.

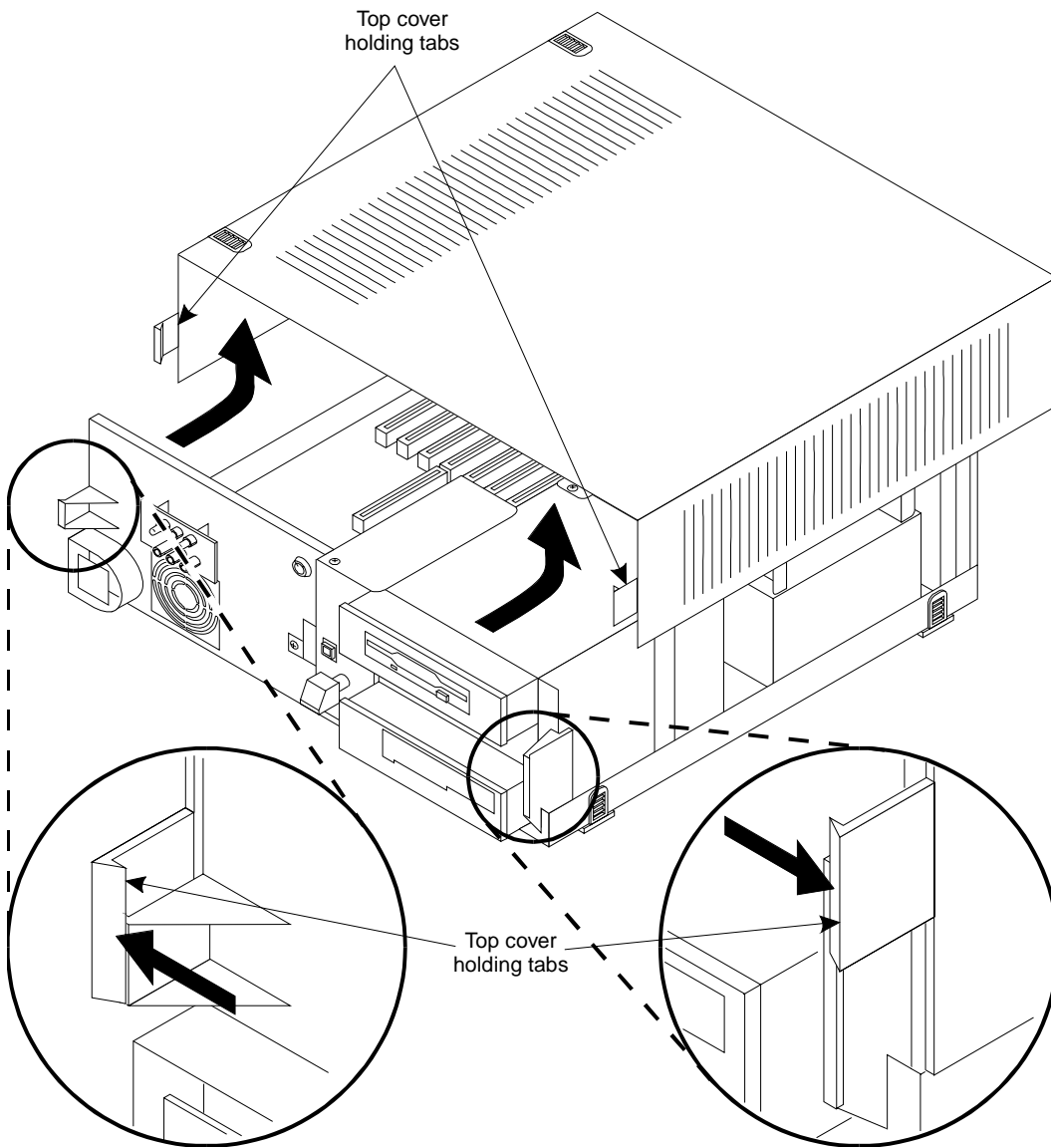

Figure 2-10. Removing the Top Cover on the MAP/5

MAP/5: Locate and Remove the GP Synch or DCIU Circuit Card

To locate and remove the GP Synch or DCIU Circuit card:

1. Locate the GP Synch or DCIU circuit card in the MAP.

MAP/5 systems previously integrated with a DEFINITY Communications System using a DCIU integration will contain either a GP Synch or a DCIU circuit card (Figure 2-11).

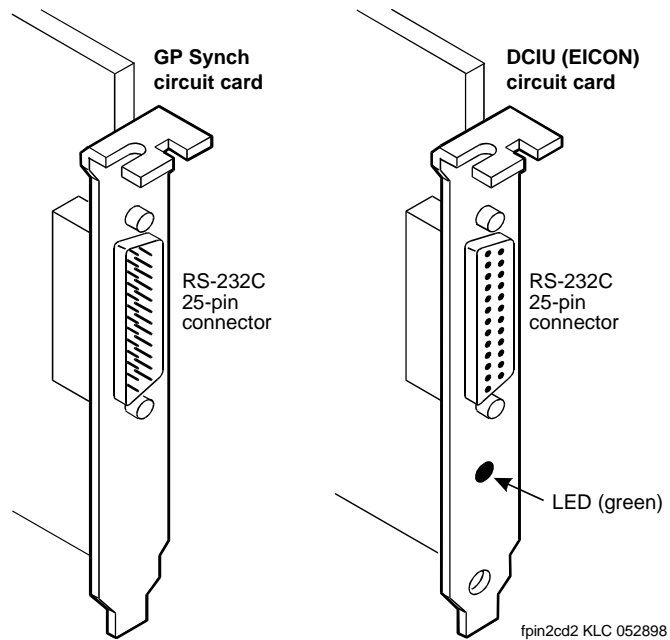

Figure 2-11. GP Synch and DCIU Circuit Card Faceplates

The card can be located in Slot 1, 3, 4, 6, or 7.

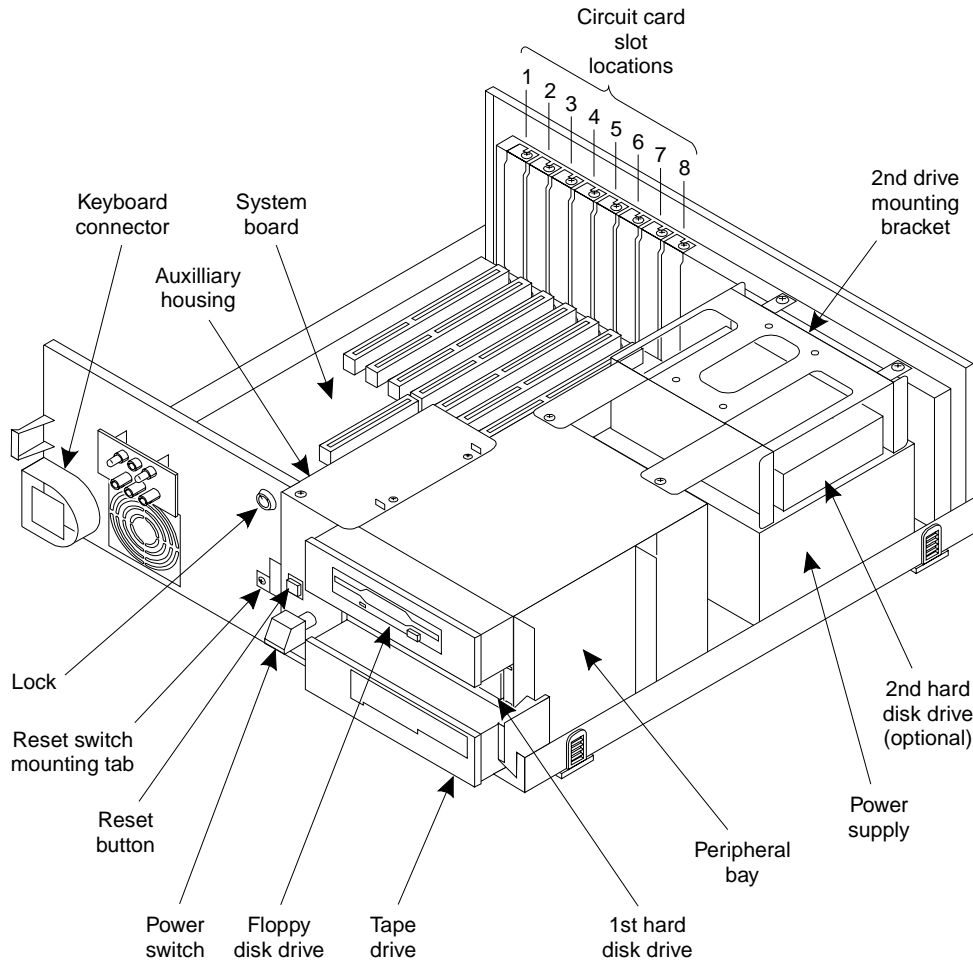

Figure 2-12. MAP/5 Slot Locations

2. Remove the circuit card retaining screw from the faceplate.
3. If a metal slot cover is available, insert the slot cover and replace the retaining screw.
4. Continue with "MAP/5: Replace the Top Cover and Cables".

MAP/5: Replace the Top Cover and Cables

1. Replace the top cover by aligning the top cover with the unit so that the front of the top cover is about 1/2-inch from the front of the unit.
2. Lower the cover over the unit until the cover is parallel with the bottom of the unit.

3. Pull the top cover toward you until it snaps into the locking tabs located on either side of the front of the unit.
4. Lock the system unit by inserting the key into the lock and turning clockwise to the locked position.
5. Align the front panel with the front of the unit and hook the top flanges of the panel underneath the top cover.
6. Lower the panel and snap into position so that the panel latches have caught. Make sure the power button is correctly aligned during this step to avoid damage.



WARNING:

The front panel fits tightly around the streaming tape drive. You may have to adjust the panel to put it on. This may cause the power switch to be pushed in.

7. Reconnect any cords or lines that you removed from the system.
8. Reconnect the monitor and the keyboard.
9. Reconnect the power cords.
10. Apply power to the system.

The system initiates the Power-On Self Test (POST).

The following appears on the screen and the system waits here for approximately 15 seconds.

486SX BIOS V1.2R1.5tt1

020096 KB Memory Good

000384 KB Shadow Ram

000128 KB Cache Ram

11. Continue with Task 8, "Allow the System to Finish Booting" on page 2-28.

MAP/40 Instructions

For additional information about the MAP/40, see *INTUITY MAP/40 Hardware Installation*, 585-310-138.

MAP/40: Open the MAP

1. Remove the incoming AC power cord, keyboard, and video cord.
2. Tag the power cord plugs with a note indicating that nobody other than yourself should reconnect power to this equipment.
3. Remove the front bezel.
 - a. Remove the top tape and floppy drive cover, located at the top of the front panel, if the system has one. Push up from the bottom of the tape and floppy drive cover, above the power switch, to release the cover (Figure 2-13, labeled #1).

-
- b. Remove the fan filter and cover. Press down on the top edge of the cover, below the power switch, to release it (Figure 2-13, labeled #2).
 - c. Pull off the bezel panel. The panel is attached by 2 fasteners at the top and 2 at the bottom (Figure 2-13, labeled #3).
 4. Remove the screws holding the dress cover (Figure 2-13, labeled #4).
 5. Slide the dress cover forward and remove it (Figure 2-14, labeled #5).
 6. (Optional) Place the MAP/40 on its side to more easily work within the chassis. Use one of the following methods:
 - a. Place the MAP/40 on its side on a work table with the support base over the table edge. You may need to disconnect incoming lines to do this. Label all disconnected lines.
 - b. If you cannot disconnect incoming lines to the MAP/40, place the MAP/40 on its side on the floor and rest the end opposite the support base on large telephone books or similar objects to protect the support base.
 7. Loosen the flat-head 1/4 inch length screws holding the access cover by *two turns only* (Figure 2-14, labeled #6).



NOTE:

It is not necessary to remove these screws. They only need to be loosened to provide adequate clearance.

8. Apply pressure gently with your hands, palms down on the access cover and slide the cover back, towards the rear of the chassis.
9. Lift up and remove the cover once it has cleared the screws.

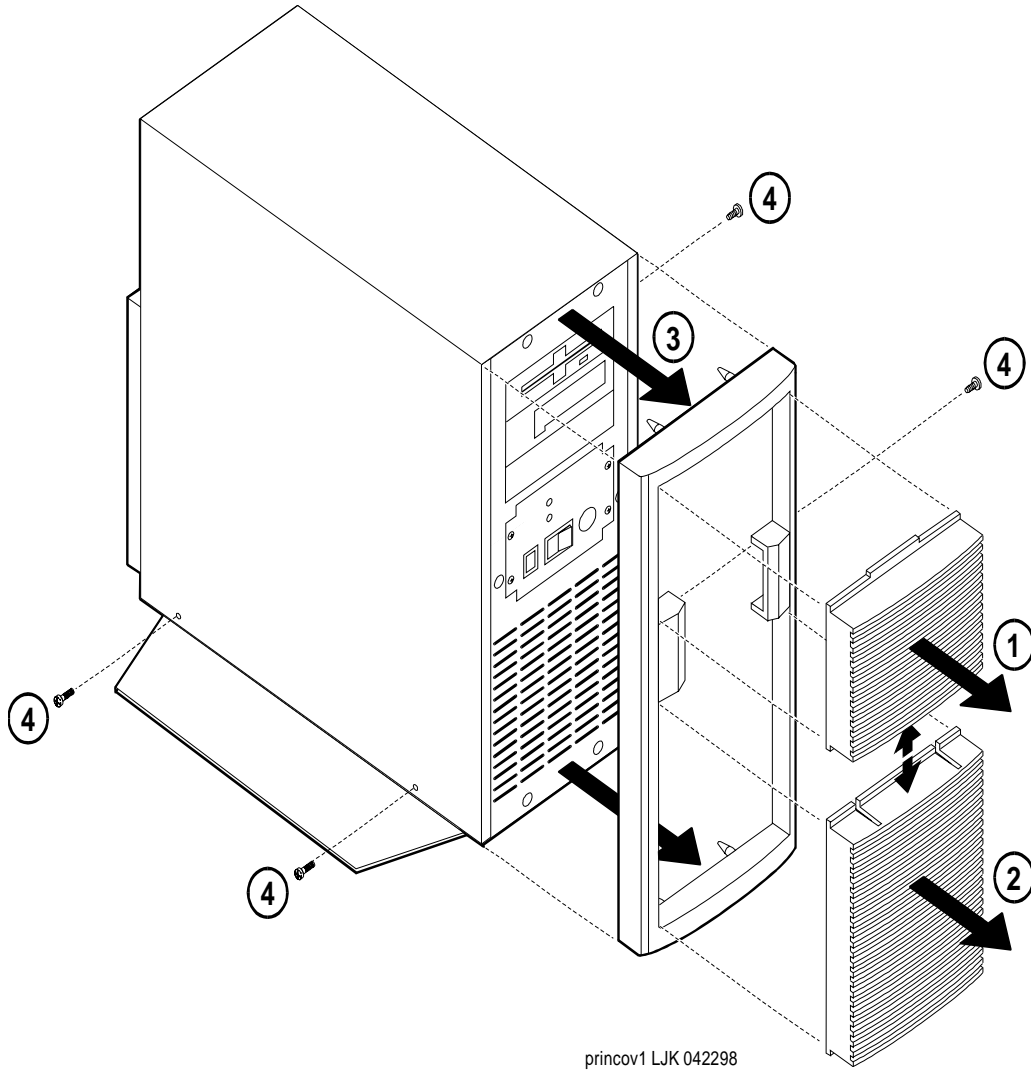
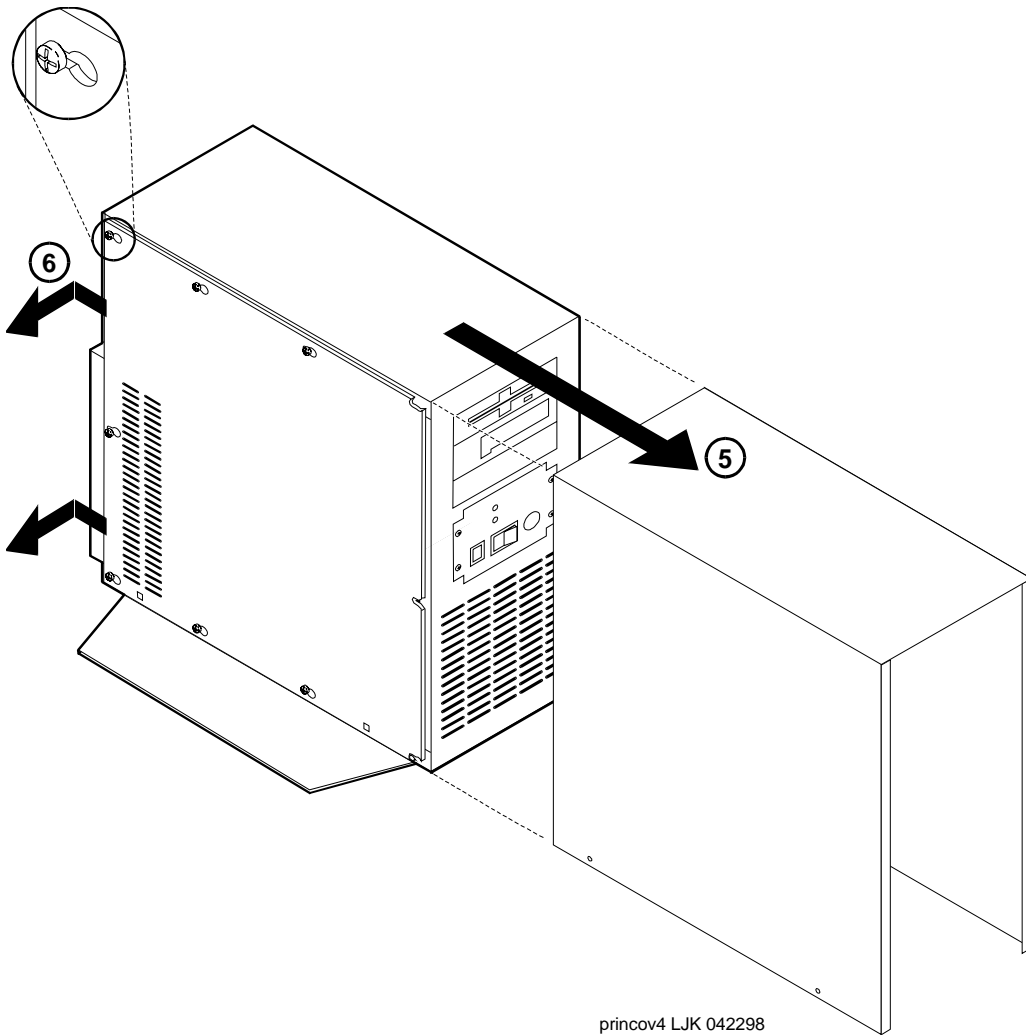

Figure 2-13. Remove the Bezel and the Dress Cover Screws



princov4 LJK 042298

Figure 2-14. Remove the Dress and Access Covers

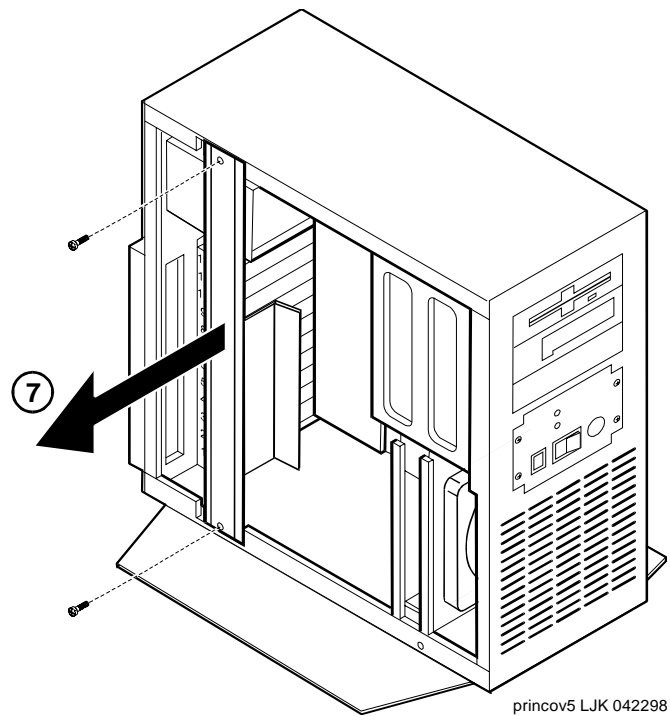

Figure 2-15. Remove the Retaining Bracket

10. Remove the circuit card retaining bracket. Locate and remove the two Phillips head screws that fasten the bracket to the chassis (Figure 2-15, labeled #7).
11. Continue with "MAP/40: Locate and Remove the GP Synch or DCIU Circuit Card".

MAP/40: Locate and Remove the GP Synch or DCIU Circuit Card

To locate and remove the GP Synch or DCIU Circuit card:

1. Locate the GP Synch or DCIU circuit card in the MAP.

MAP/40 systems previously integrated with a DEFINITY Communications System using a DCIU integration will contain either a GP Synch or a DCIU circuit card (Figure 2-16).

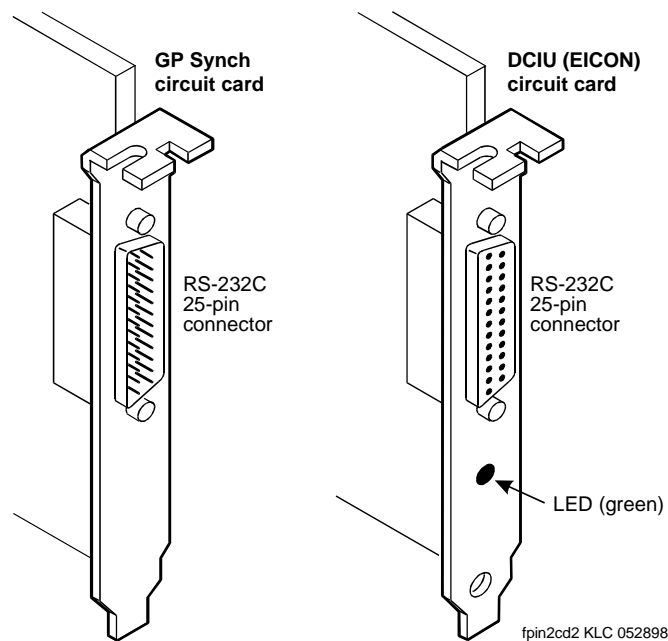

Figure 2-16. GP Synch and DCIU Circuit Card Faceplates

2. Remove the circuit card retaining screw from the faceplate.
3. If a metal slot cover is available, insert the slot cover and replace the retaining screw.
4. Continue with "MAP/40: Replace the Cover and Cables".

MAP/40: Replace the Cover and Cables

1. Recheck all the cable dressing (routing) and connections.
2. Replace the circuit card retaining bracket.
3. Replace the circuit card access panel.
4. Replace the exterior dress cover.
5. Replace the front bezel:
 - a. Place the bezel frame onto the MAP. It should snap into place.
 - b. Replace the fan filter and cover. The narrow tab should be inserted in the bottom slot.
 - c. Replace the top tape and floppy drive cover, located at the top of the front panel, if the system has one. The narrow tab should be at the top.

6. Reconnect any lines that you have removed.
7. Reconnect the monitor and keyboard.
8. Reconnect the power cords.
9. Apply power to the system and watch the monitor.

The system responds with a series of memory checks followed by the statement:

Press <ESC> to Enter Setup After Memory Test

10. Continue with Task 8, "Allow the System to Finish Booting" on page 2-28.

MAP/100 Instructions

For additional information about the MAP/100, see *INTUITY MAP/100 Hardware Installation*, 585-310-139.

MAP/100: Open the MAP

1. Remove the incoming AC power cord, keyboard, and video cord.
2. Tag the power cord plugs with a note indicating that nobody other than yourself should reconnect power to this equipment.
3. In one corner of the top dress cover, place your fingertips in the space between the bottom of the top cover and the top of the side cover. Gently pry off the dress cover by applying upward pressure at each corner.
4. Place your fingertips at the top of the left-side dress cover. Gently pry off the dress cover by applying outward pressure at each corner.
5. Loosen the eight 1/4-turn fasteners around the card cage access door (Figure 2-17) and open the door.

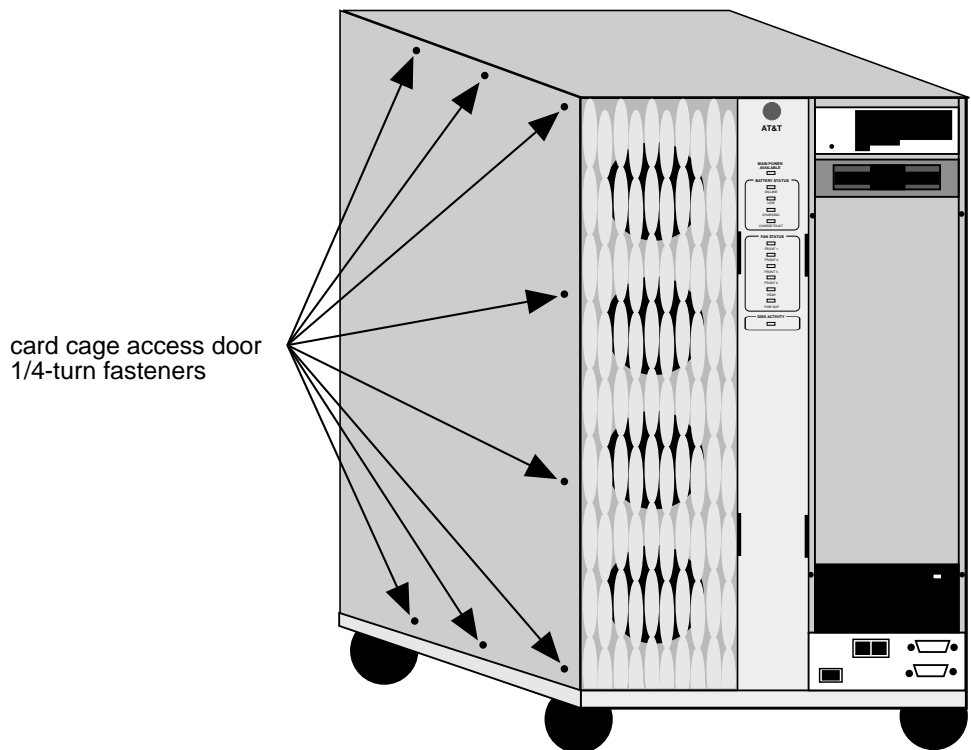

Figure 2-17. Fasteners Around the Card Cage Access Door

6. Continue with "MAP/100: Locate and Remove the GP Synch or DCIU Circuit Card".

MAP/100: Locate and Remove the GP Synch or DCIU Circuit Card

To locate and remove the GP Synch or DCIU Circuit card:

1. Locate the GP Synch or DCIU circuit card in the MAP.

MAP/100 systems previously integrated with a DEFINITY Communications System using a DCIU integration will contain either a GP Synch or a DCIU circuit card (Figure 2-18). The card will be located in Slot #20.

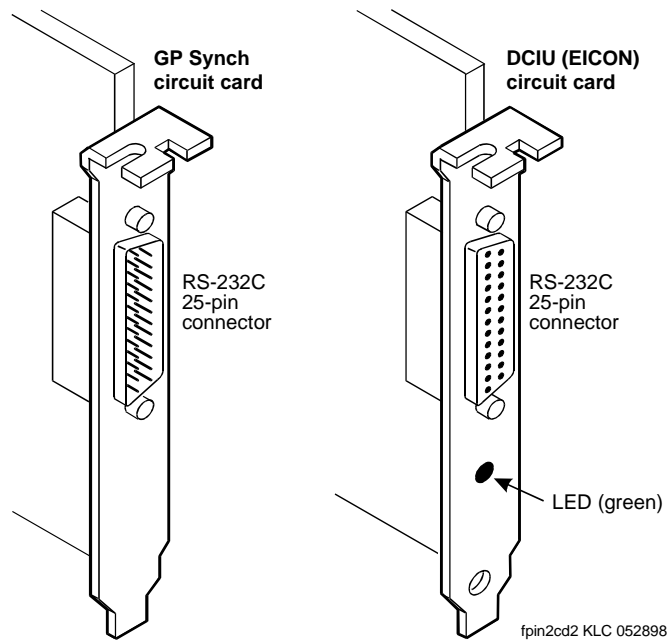

Figure 2-18. GP Synch and DCIU Circuit Card Faceplates

2. Remove the circuit card retaining screw from the faceplate.
3. If a metal slot cover is available, insert the slot cover and replace the retaining screw.
4. Continue with "MAP/100: Replace the Covers and Cables".

MAP/100: Replace the Covers and Cables

1. Check all the cable dressing (routing) and connections.
2. Close the Card Cage door.
3. Tighten the eight 1/4-turn fasteners around the card cage access door (Figure 2-17).
4. For the side covers: Align the holes on the back of the cover with the pegs on the MAP/100. Push the cover on by applying inward pressure at each of the corners.
5. For the top cover: Align the holes on the bottom of the cover with the pegs on the MAP/100. Push the cover on by applying downward pressure at each of the corners.
6. Reconnect any lines that you have removed. Reconnect the monitor and keyboard.
7. Reconnect the power cords.
8. Apply power to the system and watch the monitor.

The system responds with a series of memory checks followed by the statement:

Press <ESC> to Enter Setup After Memory Test.

9. Continue with Task 8, "Allow the System to Finish Booting".

Task 8 - Allow the System to Finish Booting

Allow the system to finish booting.

1. Allow the system to finish booting.

The system displays copyright and address information, runs memory tests, and then rebuilds the UNIX kernel.



CAUTION:

Do not strike (ENTER) or (ESC) during this process. The system automatically proceeds to the next step.



NOTE:

You may see one of the following errors:

Fatal Error: Unknown loadable module name in system file.

Invalid checksum

Ignore these errors. They are not true errors and no action is required.

The system then repeats the copyright and address information. This stage ends with the message:

The system is ready.

During the next stage, the system displays a console login and then the following message:

Automatically starting the voice system.

This message signals the start of the second stage, the stage that starts the voice system. This stage includes auditing a database, initializing the INTUITY AUDIX application, and running file checks. The system then displays:

Startup of the Voice System is complete.

Saving output to trace process.

Saving the output to trace process takes approximately a minute

When the system is finished, it displays the following message:

Startup of the Voice System is complete.

The system messages might wipe out the

Console Login prompt.

Please hit the <ENTER> key after the messages stop scrolling on the screen.

⇒ NOTE:

If you are working on an older system, these messages may not be displayed. Press **(ENTER)** to obtain a console prompt after the trace process message appears.

2. Press **(ENTER)** to obtain a console prompt.

The system displays a Console Login prompt:

**The system's name is Intuity
Welcome to USL UNIX system V Release 4.2 Version
Console Login:**

⇒ NOTE:

Networking can take from 5 to 15 minutes to become to fully operational.

3. Log in as *craft*.
4. Continue with Task 9, "Install the MERLIN LEGEND Switch Integration Software".

Task 9 - Install the MERLIN LEGEND Switch Integration Software

Use the following procedures to load the switch integration software.

Stop the Voice System

Perform the following steps to stop the voice system.

1. Starting at the Lucent INTUITY Main Menu, select:

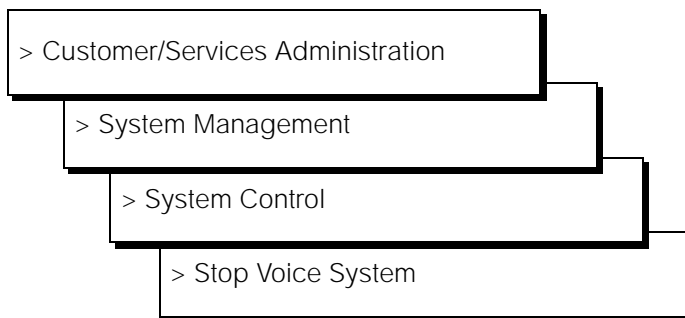

The system displays the following prompt:

Enter y to continue, n to quit.

2. Enter **y**

The system stops the voice system and returns to the System Control screen. If the system displays the following message:

The Voice System has stopped.

Press ENTER to continue.

press **ENTER** to return to the System Control screen.

3. Press **F6** (Cancel) twice to return to the Customer/Services Administration screen.
4. Continue with "Install the MERLIN LEGEND Switch Integration Software".

Install the MERLIN LEGEND Switch Integration Software

Perform the following steps to install the MERLIN LEGEND Switch Integration software:

1. Starting at the Customer/Services Administration, select:

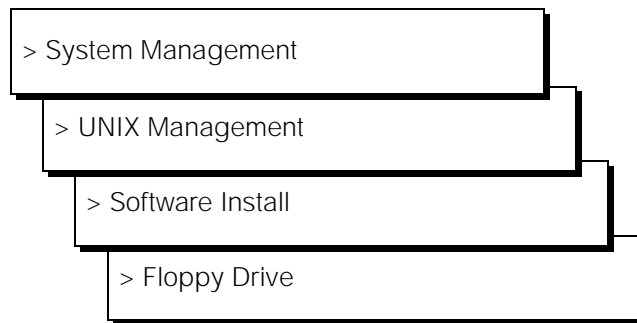

The system responds:

Insert a diskette into Floppy Drive 1.

Type [go] when ready

or [q] to quit: (default: go)

2. Insert MERLIN LEGEND Switch Integration Package Disk into the 3.5" floppy drive.
3. Press **ENTER** to install the software.

The system responds:

Installation in progress. Do not remove the diskette.

The following pkgs are available:

```
1      swin  Intuity MERLIN LEGEND
                Switch Integration Package
                (486) x.x-xx
```

Select package(s) you wish to process (or 'all' to process all packages).
(default: all) [?, ??, q]

4. Press **ENTER** to accept the default of all.

You will see messages indicating the installation is still running. When the installation is complete, you will see the following message:

**Installation of Intuity MERLIN LEGEND Switch Integration Package (swin) was successful.
Insert a diskette into Floppy Drive 1.
Type [go] when ready
or [q] to quit: (default: go)**

5. Remove the diskette from the floppy drive and insert the MERLIN LEGEND System Programming and Maintenance diskette 1.



NOTE:

Install the System Programming and Maintenance diskette 1 first.
Install diskette 2 when prompted.

6. Press **ENTER** to install the software.

The system responds:

**Installation in progress. Do not remove the diskette.
The following pkgs are available:
1 spm Intuity MERLIN LEGEND
System Programming & Maintenance Package
(486) x.x-xx
Select package(s) you wish to process (or 'all' to process all packages).
(default: all) [?, ??, q]**

7. Press **ENTER** to accept the default of all.

You will see messages indicating the installation is still running. When the installation is complete, you see the following messages:

**Installation of Intuity MERLIN LEGEND System Programming & Maintenance Package (spm) was successful.
Insert a diskette into Floppy Drive 1.
Type [go] when ready
or [q] to quit: (default: go)**

8. Remove the diskette from the floppy drive.
9. Enter **q** to quit.

The system displays the Software Install screen.

10. Press **F6** (Cancel) twice to reach the System Management screen.
11. Continue with "Start the Voice System".

Start the Voice System

Perform the following steps to start the voice system.

1. Starting at the System Management screen, select:

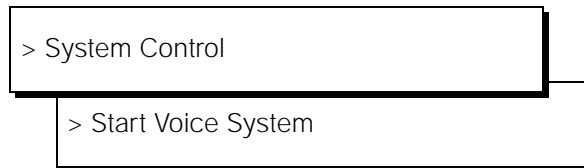

The system displays the following prompt:

The system checks the voice file directories, audits the database, runs various checks, and then displays the following prompts:

Saving output to Trace process

The system messages might wipe out the Console Login prompt

Please hit the <ENTER> key after the messages stop scrolling on the screen

Press Enter to continue ...

2. Press **[ENTER]** to return to the System Control screen.
3. Press **[F6]** (Cancel) twice to return to the Customer/Services Administration screen.
4. Continue with Task 10, "Administer the Lucent INTUITY System for Operation with the MERLIN LEGEND".

Task 10 - Administer the Lucent INTUITY System for Operation with the MERLIN LEGEND

1. Administer the switch interface on the Lucent INTUITY system. See Chapter 6, "INTUITY System Administration," in *INTUITY Integration with MERLIN LEGEND Communications System*, 585-310-255, Issue 1.

⇒ NOTE:

Do not stop and start the voice system at this time. The shutdown and turning the system off and on in the next series of tasks eliminate the need to stop and start the voice system.

2. If the channel numbering is changing (the customer is altering the dial plan), map the Lucent INTUITY channels to the switch extensions. Use "Map Channels to Switch Extensions," Channel Mapping, page A-1.

3. Perform additional administration on the Lucent INTUITY system such as routing tables and automated attendants as needed. See Chapter 6, "INTUITY System Administration," in *INTUITY Integration with MERLIN LEGEND Communications System*, 585-310-231, Issue 2.
4. Continue with Task 11, "Shutdown the Lucent INTUITY System".

Task 11 - Shutdown the Lucent INTUITY System

Shutdown the system so that you can install the cables.

1. Starting at the System Management Screen, select:

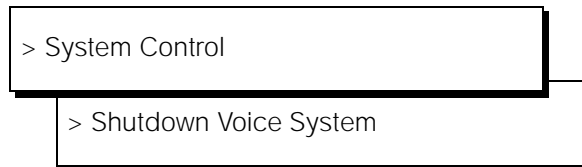

The system displays the following message:

Enter y to continue, no to quit

2. Enter **y** to continue the shutdown.

The system starts the shutdown, presents shutdown messages, and then displays the following message:

The system is down.

Press CTRL-ALT-DEL to reboot your computer.

3. Turn the power switch for the MAP to OFF:
 - On the MAP/5, the power switch is located centrally, behind the front panel. It is the green button.
 - On the MAP/40, the power switch is located on the front of the MAP, in the center, to the right-hand side.
 - On the MAP/100, the power switch is located behind the right-hand door panel, at the bottom.



CAUTION:

On the MAP/100, do not use the power switch on the back of the MAP. If this switch is used, the MAP/100 with battery backup will continue to run because of the battery backup.

4. Continue with Task 12, "Cable the MAP and Administer the MERLIN LEGEND Communications System".

Task 12 - Cable the MAP and Administer the MERLIN LEGEND Communications System

To cable the MAP and Administer the MERLIN LEGEND Communication System:

1. Install the MERLIN LEGEND Communications system.
2. Administer the MERLIN LEGEND Communications system to operate with the Lucent INTUITY system. See Chapter 5, "MERLIN LEGEND Switch Administration," in *INTUITY Integration with MERLIN LEGEND Communications System*, 585-310-255, Issue 1.
3. Cable the Lucent INTUITY system to the MERLIN LEGEND. For instructions, see Chapter 4, "Connectivity," in *INTUITY Integration with MERLIN LEGEND Communications System*, 585-310-255, Issue 1.
4. Continue with Task 13, "Apply Power to the System".

Task 13 - Apply Power to the System

To apply power to the system:

1. Apply power to the system.

The system displays copyright and address information, runs memory tests, and then rebuilds the UNIX kernel.



CAUTION:

*Do not strike **ENTER** or **ESC** during this process. The system automatically proceeds to the next step.*



NOTE:

You may see one of the following errors:

Fatal Error: Unknown loadable module name in system file.

Invalid checksum

Ignore these errors. They are not true errors and no action is required.

The system then repeats the copyright and address information. This stage ends with the message:

The system is ready.

During the next stage, the system displays a console login and then the following message:

Automatically starting the voice system.

This message signals the start of the second stage, the stage that starts the voice system. This stage includes auditing a database, initializing the INTUITY AUDIX application, and running file checks. The system then displays:

**Startup of the Voice System is complete.
Saving output to trace process.
Saving the output to trace process takes approximately a minute**

When the system is finished, it displays the following message:

Startup of the Voice System is complete.

**The system messages might wipe out the
Console Login prompt.**

**Please hit the <ENTER> key after the messages stop
scrolling on the screen.**

⇒ NOTE:

If you are working on an older system, these messages may not be displayed. Press **(ENTER)** to obtain a console prompt after the trace process message appears.

2. Press **(ENTER)** to obtain a console prompt.

The system displays a Console Login prompt:

**The system's name is Intuity
Welcome to USL UNIX system V Release 4.2 Version
Console Login:**

3. Log in as craft.
4. Determine your next step:
 - If you changed the system's channel numbers, continue with Task 14, Test the Channels if the Mapping Changed.
 - If you did not change the system's channel numbers, continue with Task 16, Clear any Alarms.

Task 14 - Test the Channels if the Mapping Changed

If you changed the channel numbers, see Channel Mapping:

1. Verify the channel state, page A-4.
2. Assign service to channels for testing, page A-8.
3. Test each channel, page A-10.
4. Assign services to called numbers, page A-13.
5. Map services to channels for operation, page A-13.

-
6. If the dial plan changed with the addition of a new number in front of the extensions (change in range) and the system is a Release 3 IP42 or later, change the AUDIX subscriber mailbox extensions. See "Using the Change Extensions Command," on page B-1.

⇒ NOTE:

The change subscriber extensions command does not change the automated attendant numbers.

7. Determine your next step:
 - If the system has the Call Accounting System (CAS) software, continue with Task 15, "Change the CAS Switch Assignment".
 - If the system does not have CAS, continue with Task 16, "Clear any Alarms" on page 2-37.

Task 15 - Change the CAS Switch Assignment

If the system has CAS, change the switch type.

⇒ NOTE:

The CAS PBX KTX 80 diskette has information for both the System 25 and the MERLIN LEGEND integrations.

1. Starting at the Lucent INTUITY Administration menu, select:

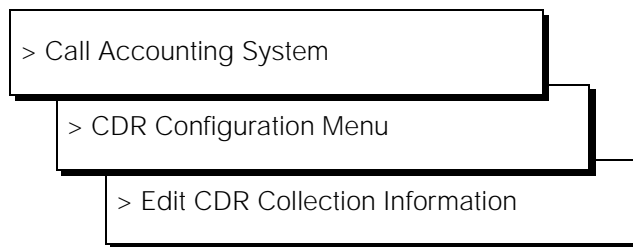

2. Change the Call Reporting field to the correct switch type.
3. Press **Ⓢ** (Cancel) until you return to the Lucent INTUITY Administration menu.
4. Continue with Task 16, "Clear any Alarms".

Task 16 - Clear any Alarms

Check the system for alarms. If the alarm has a major or a minor alarm, contact your remote maintenance center.

⇒ NOTE:

During this stage of the conversion, the system may have active switch alarms since the link has not yet been placed back into service. If you see switch link alarms, continue with these procedures and check the Alarm Log after putting the link into service.

1. Starting at the Lucent INTUITY Administration menu, select:

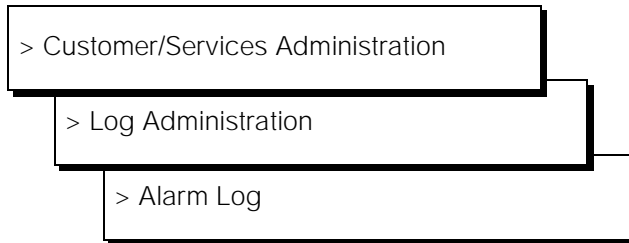

2. Administer the Alarm Log Display Selection screen for active alarms (A), major, minor, and warning alarms (y), and the time just shortly before you started the upgrade.
3. Press **F3** (Save).
4. The system displays the Alarm Log (Figure 2-19).

Alarm Log							
App	Resource	Alarm	Alm	Ack	Date/Time	Date/Time	Resolve
	Type	Code	Lvl		Alarmed	Resolved	Reason

Figure 2-19. Alarm Log Display Screen

5. Contact your remote maintenance center for assistance with any major or minor alarms.

-
6. Press **(F6)** (Cancel) three times to return to the Lucent INTUITY Administration menu.
 7. Continue with Task 17, "Place Test Calls to the System".

Task 17 - Place Test Calls to the System

To place test calls to the system:

1. Place random test calls to the system to verify that the system is answering.



NOTE:

If you want to view the system monitor during the calls, select from the Lucent INTUITY Administration menu:

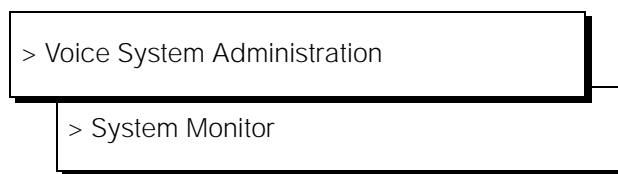

2. Continue with Task 18, "Assign the System Date and Time".

Task 18 - Assign the System Date and Time

To assign the system date and time:

1. Starting at the Lucent INTUITY Administration menu, select:

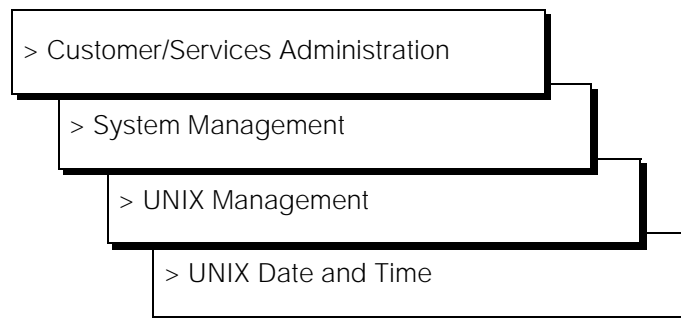

The system responds with the UNIX Date and Time screen (Figure 2-20).

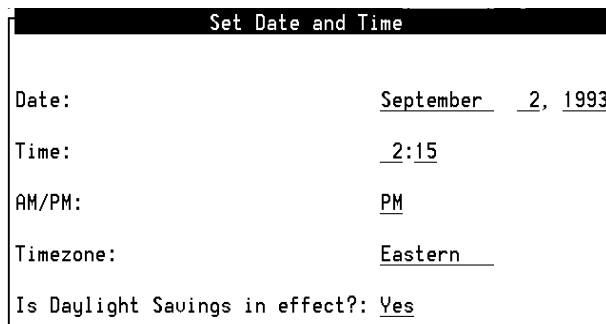

The screenshot shows a terminal window titled "Set Date and Time". The fields are as follows:

Date:	September 2, 1993
Time:	2:15
AM/PM:	PM
Timezone:	Eastern
Is Daylight Savings in effect?:	Yes

Figure 2-20. Set Date and Time Screen

2. Check the date and time information.
 - If the information is accurate, press **(F6)** (Cancel) three times to reach the Customer/Services Administration screen.
 - If the date or time is not accurate, continue with Step 3.
- ⇒ NOTE:**
You must match the time on the INTUITY system to the time on the switch.
3. Place the cursor on the field that you want to change. Use the arrow keys or **(ENTER)** to move the cursor to the field.
 4. Press **(F2)** (Choices) to display the options for the field, or if the field is for the current time, use a 12-hour AM/PM standard. **Do not use the 24-hour military standard.**
 5. Determine your next step:
 - If you made changes to the screen:
 - a. Press **(F3)** (Save) to save the changes.
 - b. Press **(F6)** (Cancel) until you logoff the system. When you log back onto the system for the next procedure, the date and time changes will take affect.
 - c. Log back into the system as craft.
 - d. Continue with Step 6.
 - If you did not make any changes to the fields, continue with Step 6.
 6. Determine your next step:
 - If you changed the Lucent INTUITY system's channel mapping or the subscriber's extensions, continue with Task 19, "Stop the Voice System"
 - If you did not change the system's channel mapping or the subscriber's extensions, determine your next step:

-
- If the system has Alarm Origination, continue with Task 22, "Activate Alarm Origination" on page 2-42
 - If the system does not have Alarm Origination, continue with Task 24, "Replace the Nightly Backup Tape" on page 2-47



CAUTION:

If you do not perform the second system data backup, the backup tape will not have the integration information for the MERLIN LEGEND or MERLIN MAGIX integration until the system completes a nightly backup.

Task 19 - Stop the Voice System

The following procedure describes how to stop the Lucent INTUITY voice system.

1. Starting at the Customer/Services Administration menu, select:

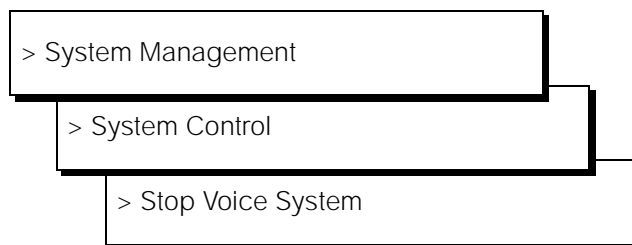

The system displays the following prompt:

Enter y to continue, n to quit.

2. Enter **y**

The system stops the voice system and returns to the System Control screen. If the system displays the following message:

**The Voice System has stopped.
Press ENTER to continue.**

3. Press **ENTER** to return to the System Control screen.
4. Press **F6** (Cancel) twice to return to the Customer/Services Administration screen.
5. Continue with Task 20, "Back Up the System-Data".

Task 20 - Back Up the System-Data

1. Use Task 4, "Make an Attended Back-up Tape," on page 2-6 to back up the System-Data.
2. Determine your next step:
 - If the system has Alarm Origination, continue with Task 22, "Activate Alarm Origination," on page 2-42, after placing the test calls.
 - If the system does not have Alarm Origination, continue with Task 21, "Start the Voice System".

Task 21 - Start the Voice System

The following procedure describes how to start the Lucent INTUITY voice system.

1. Starting at the Customer/Services Administration menu, select:

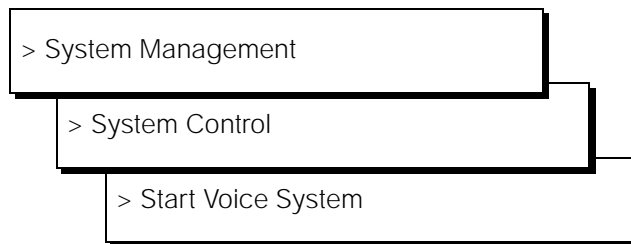

The system checks the voice file directories, audits the database, runs various checks, and then displays the following prompts:

Saving output to Trace process

The system messages might wipe out the Console Login prompt

Please hit the <ENTER> key after the messages stop scrolling on the screen

Press Enter to continue ...

2. Press **(ENTER)** to return to the System Control screen.
3. Press **(F6)** (Cancel) twice to return to the Customer/Services Administration screen.
4. Determine your next step:
 - If the system has alarm origination, continue with Task 22, "Activate Alarm Origination".
 - If the system does not have alarm origination, continue with Task 24, "Replace the Nightly Backup Tape".

Task 22 - Activate Alarm Origination

The following procedure creates an acceptance test that verifies and sends a message to the remote maintenance center. This test demonstrates that the connection is good, the system is prepared to automatically transmit alarms, and the designated remote maintenance center is ready to accept alarms for this system. This procedure tests the path from the Lucent INTUITY system to the remote maintenance center.

1. Starting at the Customer/Services Administration screen, select:



> Alarm Management

The system displays the Alarm Management screen (Figure 2-21).

2. Determine your next step:
 - If the Product ID and Alarm Destination fields are administered, continue with Step 3.
 - If the Product ID and Alarm Destination fields are not administered, enter the information now. After entering the information, continue with Step 3.

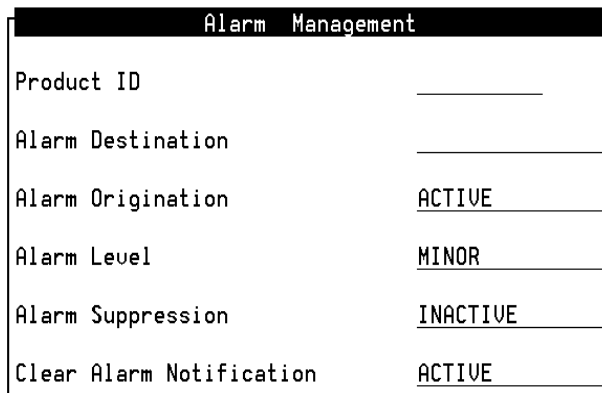

Alarm Management	
Product ID	_____
Alarm Destination	_____
Alarm Origination	ACTIVE
Alarm Level	MINOR
Alarm Suppression	INACTIVE
Clear Alarm Notification	ACTIVE

Figure 2-21. Alarm Management Screen

3. Move the cursor to the Alarm Origination field.
4. Press **F2** (Choices).

The system displays the Alarm Origination screen (Figure 2-22).

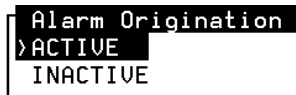

Figure 2-22. Alarm Origination Menu

5. Select ACTIVE.
The system changes the entry to ACTIVE.
6. Press **F3** (Save).



CAUTION:

Do not omit this step even if you did not make any changes to the screen.

The system displays an Information screen (Figure 2-23).

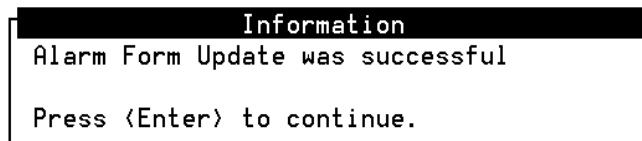

Figure 2-23. Information Screen

7. Press **ENTER**.
The system returns to the Alarm Management screen.
8. Press **F8** (Change Keys).
9. Press **F1** (Test Alarm).
The system displays the Alarm Origination Test screen (Figure 2-24).

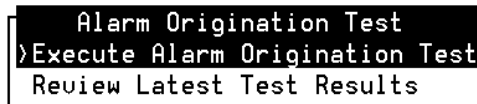

Figure 2-24. Alarm Origination Test Menu

-
10. Select `Execute Alarm Origination Test` from the Alarm Origination Test screen.

The system displays the following messages:

**Alarm Origination tests may take up to
5 minutes to complete. This test will
be run in the background.**

**Press <y> to confirm.
Press <n> to cancel.**

11. Enter `y`
The system returns to the Alarm Origination Test screen.
12. Wait approximately 1 minute.
13. Select `Review Latest Test Results` from the Alarm Origination Test screen.

The system displays the Alarm Origination Test Results screen (Figure 2-25).

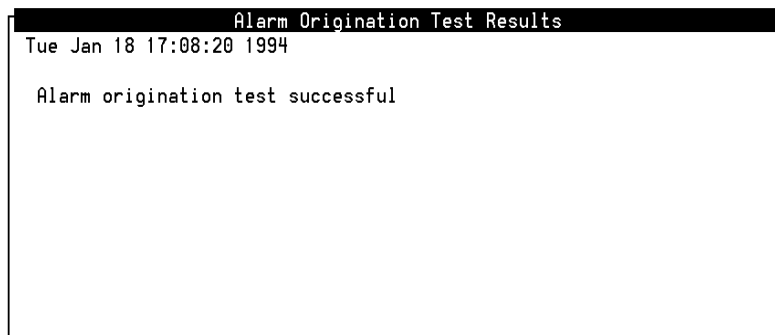

Figure 2-25. Alarm Origination Test Results Screen

14. Verify that the Alarm Origination Test Results screen does not contain any error messages such as "Alarm port busy".
If you see any error messages, contact your remote maintenance center or see *INTUITY Platform Administration and Maintenance*.
15. Press `F6` (Cancel) to return to the Alarm Origination Test Results screen.
16. Wait approximately 4 minutes.
17. Select `Review Latest Test Results`.

18. Verify that the message on the screen reads:

Day Date Time

Alarm origination test successful.

The entry on the screen should correspond with the time that you sent the alarm.

If the test does not complete successfully, complete the following before contacting your remote maintenance center:

- a. Wait a few more minutes and check the test results again. If the test still reports that it is in progress, continue with Step b.
 - b. Check the telephone number for the remote maintenance center on the Alarm Management screen. If this is wrong, the test will not complete.
 - c. Verify that the telephone is connected to the modem or RMB. If the line has problems, the RMB can remain in the testing state, waiting for the remote maintenance center to answer.
19. Press **ⓧ** (Cancel) four times until you reach the Lucent INTUITY Administration menu.
 20. Continue with Task 23, "Create a Test Alarm".

Task 23 - Create a Test Alarm

Use the following procedure to create a test alarm. This alarm sends a request to the remote maintenance center to update their database, and places a minor alarm on the system.

1. Starting at the Lucent INTUITY Administration menu, select:

> AUDIX Administration

The system displays the AUDIX Administration screen (Figure 2-26).

```
AUDIX           Active           Alarms:           Logins: 1
```

```
enter command: |
```

Figure 2-26. AUDIX Administration Screen

2. Type **test alarm-origination** at the `enter command:` prompt at the bottom left side of the screen.

⇒ NOTE:

If the system does not accept this command, exit the AUDIX screen and continue with the next task.

3. Press `F3` (Enter).

The system displays the following message:

To activate the test alarm, press ENTER. This alarm will retire itself automatically in thirty minutes.

If logged in remotely, please log off as soon as possible after pressing ENTER.

4. Press `F3` (Enter).

The system clears the AUDIX screen field and displays an `m` for minor alarm in the Alarms field at the top, center of the screen.

5. Type **exit** and press `ENTER`

The system returns to the Lucent INTUITY Administration menu.

6. Press `F6` (Cancel) until you log out of the system.

Task 24 - Replace the Nightly Backup Tape

Return the nightly backup tape to the tape drive.

⇒ NOTE:

Failure to return the nightly backup tape to the tape drive results in a system alarm when the system attempts the next nightly backup. This alarm remains on the system until a successful backup is completed.

Task 25 - Remove the Old Software from the Site

Remove the old switch integration software from the site to prevent loading the wrong software in the event of a failure.

Channel Mapping

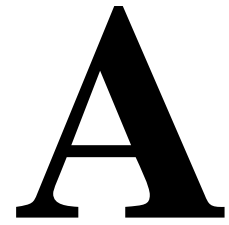

Overview

This appendix presents the information necessary to perform channel mapping and acceptance testing.

⇒ NOTE:

The platform administration of channels to groups is not performed in this release. Allow the setting to remain at 2. This Assign screen option is reserved for future use.

Administer the INTUITY Switch Interface

You must first Administer the INTUITY switch interface before you can map channels to switch extensions. If you have not administered the INTUITY Switch Interface, see Chapter 2, "Conversion Instructions," Task 10, "Administer the Lucent INTUITY System for Operation with the MERLIN LEGEND" on page 2-32.

Map Channels to Switch Extensions

This procedure assigns an extension number to each activated channel. Only those channels that have been purchased and activated can be assigned.

⇒ NOTE:

Channels not purchased and activated are not displayed on the *Voice Equipment* screen.

1. Starting at the INTUITY Administration menu, select:



The system responds with the Voice Equipment screen, as shown in Figure A-1.

⇒ NOTE:

The channel state, shown in the third column of the Voice Equipment screen, may be in-service (Inserv), facility-out-of-service (FOOS), or manually-out-of-service (Manoos).

Voice Equipment							
Card	0 is IUC6	O.S.Index: 0	Function: TipRing				
CD.PT	CHN	STATE	STATE-CHNG-TIME	SERVICE-NAME	PHONE	GROUP	TYPE
0.0	0	Manoos	Mar 28 06:27:48	*DNIS_SVC	6427	2	IUC6
0.1	1	Manoos	Mar 28 06:27:48	*DNIS_SVC	-	2	IUC6
0.2	2	Manoos	Mar 28 06:27:48	*DNIS_SVC	-	2	IUC6
0.3	3	Manoos	Mar 28 06:27:48	*DNIS_SVC	-	2	IUC6
0.4	4	Manoos	Mar 28 06:27:48	*DNIS_SVC	-	2	IUC6
0.5	5	Manoos	Mar 28 06:27:48	*DNIS_SVC	-	2	IUC6

Figure A-1. Voice Equipment Screen Before Administration (Newly Installed Circuit Card)

In this screen, the INTUITY system uses the following abbreviations:

- CHN: channel
- CD.PT: card number and port
- STATE: current port state
- STATE-CHG-TIME: the time that the change to the current port state occurred
- GROUP: a number may or may not appear in this field. This field is not currently used for the INTUITY system. Leave this setting as 2, the default.

2. Press (F8) (Change Keys) to display the voice equipment function keys.

3. Press **F3** (Assign) to display the assignment options.



NOTE:

The channel may be in any state for this procedure.

The system responds with the Assign screen, as shown in Figure A-2.

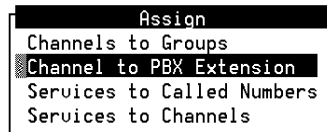

Figure A-2. Assign Screen

4. Select **Channel to PBX Extension** from the Assign screen.
5. Press **ENTER** to display the screen to map the channels to the extensions.

The system responds with the Channel to PBX Extension screen, as shown in Figure A-3.

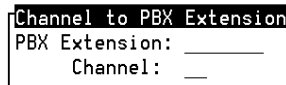

Figure A-3. Channel to PBX Extension Screen

6. Enter the switch extension for the appropriate channel in the PBX Extension field of the Channel to PBX Extension screen. Use the worksheet listing the channels and extensions. The extension number may have up to 7 digits.



CAUTION:

If the mapping is incorrect, some or all of the channels may be answered with the incorrect service or greeting.



NOTE:

Typing over the previous entry removes the old numbers from the fields. It is not necessary to use the **DELETE** or backspace keys on the keyboard.

7. Enter the appropriate channel number in the Channel field.
8. Press **F3** (Save).

An information screen appears confirming that the switch extension has been mapped to the channel.

9. Press **ENTER** to continue.



NOTE:

The Voice Equipment screen is not updated until the Channel to PBX Extension screen is closed. If you wish to verify your mapping at any time during the procedure, press the **F6** (Cancel) key twice to cancel out of the Channel to PBX Extension and the Assign screen. This will cause the INTUITY system to redraw the Voice Equipment screen.

10. Repeat Steps 6 through 9 for each channel that needs a switch extension.
11. Press **F6** (Cancel) until you reach the INTUITY Administration menu.
12. Return to Task 10, "Administer the Lucent INTUITY System for Operation with the MERLIN LEGEND" on page 2-32.

Verify Channel State

The procedure is used to verify that the state of the channel is in-service (Inserv) and that the channels are ready to be tested.

The INTUITY system has four possible port states:

- In-Service (Inserv)
Channel is ready to accept telephone calls. There may be active calls on this channel if the system is operational.
- Facility-out-of-service (Foos)
The channel is not in-service. The Foos state occurs when a channel has been released through the *Voice Board Diagnostics* screen to Inserv, and it does not detect loop current. A channel in the Foos state should automatically convert to the Inserv state when it detects loop current, but it may need to be reset.
- Manually-out-of-service (Manoos)
The channel has been busied-out under the *Voice Board Diagnostics* screen, or the channel is on a new IVC6 circuit card. A channel in the Manoos state will remain in the Manoos state until it is released under the *Voice Board Diagnostics* screen.
- Non-Existent (NONEX or no entry on any screen)
The system does not see the channel. The system will not see a channel that has not been properly activated even if the IVC6 is present. To change a channel from non-existent to recognized, the remote maintenance center must activate it.

Channels are usually shipped from the factory in the facility-out-of-service (Foos) state. When the ports detect loop current, they automatically convert to the Inseru state.

If you have connected the ports to the switch and they remain in the Foos state, you may have a problem with the:

- Connection
- Switch
- Hardware

If you are installing a new board, you will see the manually-out-of-service state (MANOOS). If MANOOS appears for a channel, you will need to convert it to Inseru or Foos by using the second half of this procedure.

⇒ NOTE:

If you are already displaying the Voice Equipment screen, begin this procedure at Step 2.

1. Starting at the INTUITY Administration menu, select:



The system responds with the Voice Equipment screen, as shown in Figure A-4.

Voice Equipment							
CD.PT	CHN	STATE	STATE-CHNG-TIME	SERVICE-NAME	PHONE	GROUP	TYPE
Card 0 is IVC6				O.S.Index: 0	Function: TipRing		
				State: Inseru			
0.0	0	Inseru	Sep 21 13:59:12	-	2013	-	IVC6
0.1	1	Inseru	Sep 21 13:59:12	-	2014	-	IVC6
0.2	2	Inseru	Sep 21 13:59:12	-	2015	-	IVC6
0.3	3	Inseru	Sep 21 13:59:12	-	2016	-	IVC6
0.4	4	Inseru	Sep 21 13:59:12	-	2017	-	IVC6
0.5	5	Inseru	Sep 21 13:59:12	-	2018	-	IVC6
Card 1 is IVC6				O.S.Index: 1	Function: TipRing		
				State: Inseru			

Figure A-4. Voice Equipment Screen

2. Verify that all of the channels that are listed are in the in-service (Inserv) state. This state is listed in the `state` column of the display. Use either the up and/or down arrow keys to scroll through the channel listings, or use the `F2` (Previous Page) and `F3` (Next Page) keys.
3. Continue with "Assign Service to Channels for Testing" on the next page. If you need to make any changes to any channel states, continue with this procedure.
4. Press `F6` (Cancel) twice to reach the INTUITY Administration menu.
5. Starting at the INTUITY Administration menu, select:

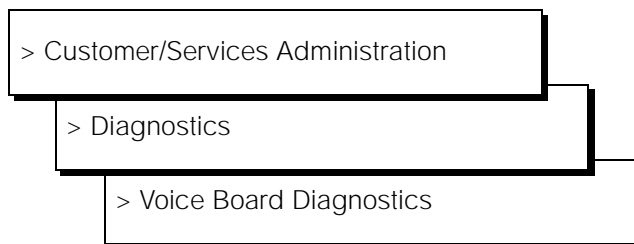

The system responds with the Diagnose Voice Equipment screen, as shown in Figure A-5.

⇒ NOTE:

Ports will be in the manually-out-of-service (Manoos) state if you are installing a new board. These will transition to in-service (Inserv) when they are released if the board detects loop current. If released ports transition to or remain facility-out-of-service, the ports are not detecting any loop current.

Diagnose Voice Equipment							
CHN	CD.PT	STATE	STATE-CHNG-TIME	SERVICE-NAME	PHONE	GROUP	TYPE
0	0.0	Manoos	Nov 23 09:57:15	-	1111	-	IUC6
1	0.1	Manoos	Nov 23 09:57:18	-	2011	-	IUC6
2	0.2	Manoos	Nov 23 09:57:20	-	2012	-	IUC6
3	0.3	Manoos	Nov 23 10:10:49	-	2014	-	IUC6
4	0.4	Manoos	Nov 23 10:10:52	-	2018	-	IUC6
5	0.5	Manoos	Nov 23 10:10:54	-	2020	-	IUC6

Figure A-5. Diagnose Voice Equipment Screen

6. Press **F8** (Change Keys) to display the diagnose function keys.
7. Press **F3** (Release) to display the screen showing the Release of Voice Equipment screen.

The system responds with the Release of Voice Equipment screen, as shown in Figure A-6.

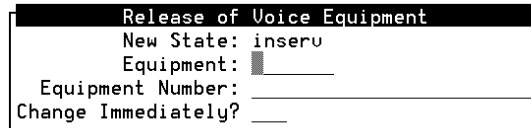

Figure A-6. Release of Voice Equipment Screen

8. Enter **ch** for channel or **ca** for card into the Equipment field. After the first two letters, the INTUITY system types the rest of the word.
9. Enter the equipment number. You can enter the card or channel numbers in several forms:
 - a single number (for example: 1)
 - a range of numbers (for example: 0-4)
 - a list of single numbers (for example: 6,9,10)
 - a list of single numbers and ranges (for example: 1,4-7,9)
 - the word 'all' to indicate that all of the cards or channels should change their states
10. Enter **y** to change the state of the equipment immediately.
11. Enter **F3** (Save) to save the changes and put them into effect.

The system responds with the Command Output screen and a message:

```
Change State Output:
Channel x changed to state y.
```

In this message, **x** is the channel number and **y** is the state of Insert or Foos.

12. Press **F6** (Cancel) until you reach the INTUITY Administration menu.
13. Continue with "Assign Service to Channels for Testing".

Assign Service to Channels for Testing

This procedure assigns the service ChanTran to all of the channels for testing.

After the testing is completed, channels will have to be assigned to their operating service. ChanTran does not support the INTUITY applications.

1. Starting at the INTUITY Administration menu, select:



The system responds with the Voice Equipment screen, as shown in Figure A-7.

Voice Equipment								
Card 0 is IUC6			O.S.Index: 0	Function: TipRing				
			State: Inseru					
CD.PT	CHN	STATE	STATE-CHNG-TIME	SERVICE-NAME	PHONE	GROUP	TYPE	
0.0	0	Inseru	Sep 21 13:59:12	-	2013	-	IUC6	
0.1	1	Inseru	Sep 21 13:59:12	-	2014	-	IUC6	
0.2	2	Inseru	Sep 21 13:59:12	-	2015	-	IUC6	
0.3	3	Inseru	Sep 21 13:59:12	-	2016	-	IUC6	
0.4	4	Inseru	Sep 21 13:59:12	-	2017	-	IUC6	
0.5	5	Inseru	Sep 21 13:59:12	-	2018	-	IUC6	
Card 1 is IUC6			O.S.Index: 1	Function: TipRing				
			State: Inseru					

Figure A-7. Voice Equipment Screen

2. Press (F8) (Change Keys) to display the voice equipment function keys.
3. Press (F3) (Assign) to display the Assign screen.

The system responds with the Assign screen, as shown in Figure A-8.

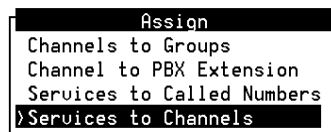

Figure A-8. Assign Screen

4. Select **Services to Channels**.
5. Press **(ENTER)** to display the services to channels screen.

The system responds with the Assign Services to Voice Channels screen, as shown in Figure A-9.

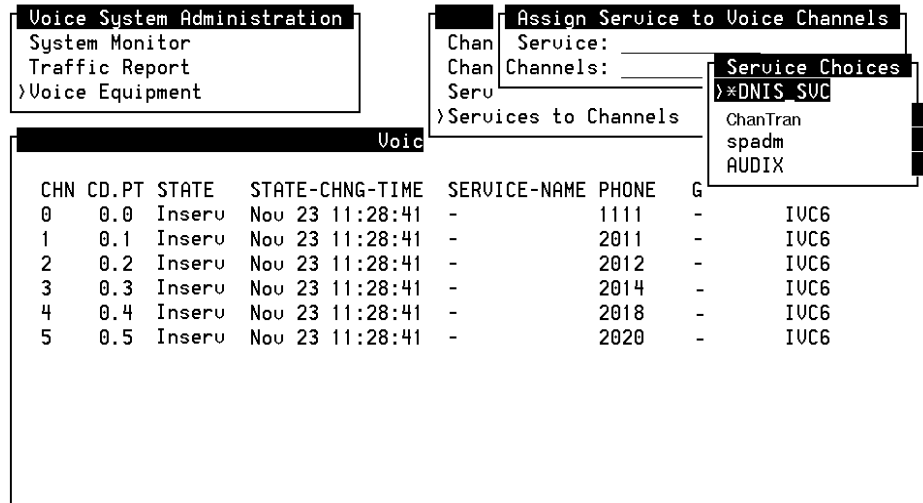

Figure A-9. Assign Services to Voice Channels Screen

6. Verify that the cursor is on the *Service* field in the *Assign Service to Voice Channels* screen.
7. Press **(F2)** (Choices) to display all possible services.
8. Select **ChanTran** for all channels.

⇒ NOTE:
ChanTran is for testing purposes only. It will not support Voice Mail or Voice Response.

9. Enter all in the *Channels* field.
10. Press **(F3)** (Save).

⇒ NOTE:
A Command Output screen verifies that the designated channels are assigned the selected service.

11. Press **(F6)** (Cancel) three times to reach the INTUITY Administration menu.
12. Continue with "Test Each Channel".

Test Each Channel

This test accepts each channel's ability to:

- Recognize touch tones
- Record and playback

Only those channels that have been purchased and activated are tested.

⇒ NOTE:

INTUITY ChanTran has blind and intelligent transfer test capabilities that may be used to test if the need arises. These transfers, however, may not work on all switches.

If you are using a speaker phone to test in an environment with background noise, you may need to use the mute button while testing touch tone recognition. Background noise will interfere with INTUITY ChanTran while using a speaker. If ChanTran does not answer when you are using a speaker phone, mute the phone to stop the background noise detection.

⇒ NOTE:

Assigning INTUITY ChanTran to a channel does not stop an operating system from answering outside calls with the re-assigned channel. If you assign ChanTran to a channel receiving outside calls, outside callers will receive the ChanTran test prompts.

1. Starting at the INTUITY Administration menu, select:

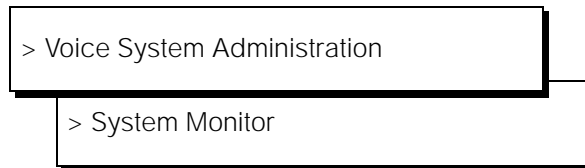

The system responds with the System Monitor - Voice Channels screen, as shown in Figure A-10.

System Monitor - Voice Channels					
Channel	Calls Today	Voice Service	Service Status	Caller Input	Dialed Digits
0	0		*On Hook		
1	10		*On Hook		
2	21		*On Hook		
3	4		*On Hook		
4	12	ChanTran	Talking	12345#	
5	0		*On Hook		

Figure A-10. System Monitor Screen Showing Channel being Tested with INTUITY ChanTran Touch Tone Recognition

2. Verify that all purchased and activated voice channels are listed as being on-hook at the start of the testing.
3. Use a test phone to dial the extension number of the channel to be tested. Begin with the extension assigned to channel 0.

The system responds:

"This is the channel and transfer test program.
 You are testing voice channel number xx¹.
 Press 1 to initiate the touch tone recognition test.
 Press 2 to initiate the call transfer test.
 Press 3 to initiate the record and playback test or press the star key to quit."

⇒ NOTE:

ChanTran features dial-through which allows you to enter numbers or commands before the message or the prompt stops playing. Dial-through, however, can only be used in ChanTran testing after ChanTran has reported the number of the channel being tested.

4. Verify that the channel number reported by ChanTran correctly matches the channel associated with the extension that you dialed.
5. Verify that the channel is listed as ChanTran Talking on the system monitor screen, as shown in Figure A-10 above. In this figure, Channel 4 is being tested for touch tone recognition.

1. xx indicates the number of the channel being tested. For example, if channel 4 were being tested, you would hear: "You are testing voice channel number 4".

6. Press 1 (the number 1) to start the touch tone recognition test.

The system responds:

"Enter a set of digits followed by the pound key.
The star and pound keys will not be spoken."

7. Enter the numbers **1 2 3 4 5** on the telephone keypad.
8. Enter the pound sign.

The system responds through the telephone:

"The digits entered are 1 2 3 4 5."

The system then returns to the main ChanTran menu, starting with:

"Press 1 to initiate..."

 **NOTE:**

If you heard the sequence of digits that you entered and saw the numbers entered on the System Monitor Screen, the test completed successfully. If you did not hear the sequence of digits that you entered or if the digits are unclear or cannot be understood, the test has failed. Contact your remote maintenance center.

9. Press 1 (the number 1) to restart the touch tone recognition test.
10. Enter the numbers **6 7 8 9 0** on the telephone keypad.
11. Enter the pound sign.

The system responds through the telephone:

"The digits entered are 6 7 8 9 0."

The system then returns to the main menu, starting with:

"Press 1 to initiate..."

12. Press (the number 3) to start the record and playback test.

The system responds:

"Press 1 to record message using CELP.²
Press 2 to record message using ADPCM32.
Or, press 3 to record message using Sub-Band 16."

13. Press 1 (the number 1) to record a message using CELP.

The system responds:

"Record test message at the tone:"

14. Record a short test message such as "Test, test, test" by speaking into the test phone. The system stops recording automatically when you stop speaking.

2. These are different voice encoding algorithms.

The system responds through the telephone:

The recorded phrase is: "Test, test, test."

The system then returns to the INTUITY ChanTran main menu, starting with:

"Press 1 to initiate..."

⇒ NOTE:

If you heard the phrase, the test has completed successfully. If you did not hear the phrase, or the repeated phrase cannot be understood, the test has failed. Contact your remote maintenance center.

15. Press the star key to disconnect from the channel.
16. Hang up the phone.
17. Verify the disconnection by looking at the System Monitor screen. The channel should return to on hook.

⇒ NOTE:

If the channel returned to on-hook, the test completed successfully.

18. Test all remaining channels by repeating Steps 3 through 17 until all channels have been tested.
19. Press **ⓧ** (Cancel) until you reach the INTUITY Administration menu.
20. Continue with "Assign Services to Called Numbers".

Assign Services to Called Numbers

During installation, the voice channels must be assigned a service. This service tells the voice channels what to do with the incoming call.

The dialed number information service (*DNIS_SVC) provides the information INTUITY needs to correctly answer the incoming call. *DNIS_SVC allows channels to be flexible, so that each channel is able to handle different applications. This makes the system more responsive: if many calls come into the system for one of the applications at the same time, the INTUITY system can answer with as many channels as is needed, up to the maximum number permitted by hardware limitations.

Before *DNIS_SVC can be used, however, *DNIS_SVC itself must be administered. This administration involves identifying the service and the incoming called number that requires the service. The following procedure to assign the services and the called numbers must be performed before the *DNIS_SVC itself is assigned to the channels.

⇒ NOTE:

Refer to the worksheet from your project manager. If you will not be assigning *DNIS_SVC to any channels, skip this procedure and continue with the next procedure, "Map Services to Channels for Operation".

1. Starting at the INTUITY Administration menu, select:



The system responds with the Voice Equipment screen, as shown in Figure A-11.

Voice Equipment							
Card 0 is IVC6		O.S.Index: 0	Function: TipRing				
		State: Inseru					
CD.PT	CHN	STATE	STATE-CHNG-TIME	SERVICE-NAME	PHONE	GROUP	TYPE
0.0	0	Inseru	Sep 21 13:59:12	CHANTRAN	2013		IVC6
0.1	1	Inseru	Sep 21 13:59:12	CHANTRAN	2014		IVC6
0.2	2	Inseru	Sep 21 13:59:12	CHANTRAN	2015		IVC6
0.3	3	Inseru	Sep 21 13:59:12	CHANTRAN	2016		IVC6
0.4	4	Inseru	Sep 21 13:59:12	CHANTRAN	2017		IVC6
0.5	5	Inseru	Sep 21 13:59:12	CHANTRAN	2018		IVC6
Card 1 is IVC6		O.S.Index: 1	Function: TipRing				
		State: Inseru					

Figure A-11. Voice Equipment Screen

2. Press **F8** (Change Keys) to display the voice equipment function keys.
3. Press **F3** (Assign) to display the assignment options.

The system responds with the Assign screen, as shown in Figure A-12.

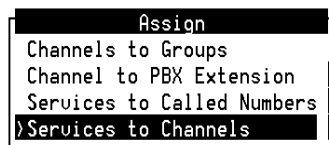
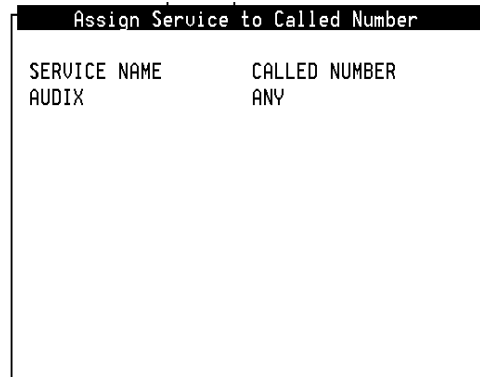

Figure A-12. Assign Screen

4. Select Services to Called Numbers from the Assign screen.
5. Press **(ENTER)** to display the screen to assign the services to the called numbers.

The system responds with the Assign Service to Called Numbers screen, as shown in Figure A-13.



SERVICE NAME	CALLED NUMBER
AUDIX	ANY

Figure A-13. Assign Service to Called Number Screen

6. Press **(F8)** (Change Keys).
7. Determine your next step:
 - a. If you are installing a new system that does not have assigned services, continue with Step 8.
 - b. If you are adding either the INTUITY AUDIX or the INTUITY Lodging application:
 1. Press **(F2)** (Remove) to display the Remove Service From Called Number screen.
 2. Enter the called number to be removed. Entering the called number will cause both the service name and the called number to be removed.
 3. Press **(F3)** (Save) to remove the service and the called number.

The system responds with a Command Output screen.
 4. Press **(F6)** (Cancel) to exit the Command Output screen.
 5. Continue with Step 8 to assign the new services.
8. Press **(F1)** (Add).

The system responds with the Add Service to Called Number screen in the upper right-hand corner of the monitor.

9. Place the cursor in the Service name to be added field.
10. Press **F2** (Choices) to display a list of the possible services.
11. Refer to the worksheet showing the services to channels. Assign the services as shown on the worksheet, by highlighting the name of the service and pressing **ENTER**.

The possible services that may be assigned to and operated under *DNIS_SVC include:

- AUDIX+ldg: allows callers access to either the INTUITY AUDIX application or the INTUITY Lodging application based upon the identity of the phone from which they are calling
- AUDIX: allows designated called number accesses the INTUITY AUDIX application.
- ldg_ni_ca: allows callers to leave a message for any guest after entering the guest's extension number.
- ldg_ni_vm: allows guests to retrieve messages from any phone after entering an extension number
- lodging: provides lodging voice mail and call answer services without entering the extension number

12. Enter the **called number** for the service.
13. Press **F3** (Save).

A command output screen appears confirming your selection to add or remove a called number from the *DNIS_SVC group, as shown in Figure A-14.

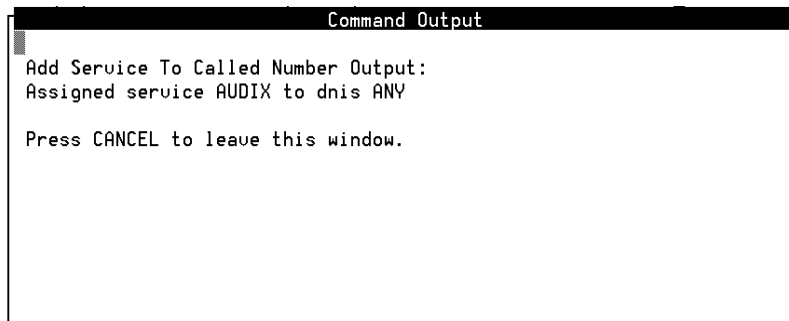

Figure A-14. Screen Confirming the Assignment of Services to Called Numbers

14. Press **F6** (Cancel) to exit the Command Output screen.

15. Repeat Step 6 through Step 12 for each service and called number assignment.
16. Press **F6** (Cancel) twice to reach the INTUITY Administration menu, or continue with the next task, "Map Services to Channels for Operation".

Map Services to Channels for Operation

This procedure assigns the channels to the services that they will use during normal operation. The service(s) that will be used for operation are recorded on the worksheet from your project manager. If you have any questions about the service assignments, contact your project manager.

⇒ NOTE:

Channels assigned to AUDIX instead of *DNIS_SVC on the INTUITY system will not be integrated. Integrated channels provide call information for the INTUITY AUDIX application. Non-integrated channels ask the caller to enter the extension number of the person to be reached. If the service name for an INTUITY Intro Voice Response application is assigned directly to the channel, the application will require the user to enter an extension number. *DNIS_SVC is the recommended service for all channels, with the services defined for *DNIS_SVC."

1. Starting at the INTUITY Administration menu, select:



The system responds with the Voice Equipment screen.

2. Press **F8** (Change Keys) to display the voice equipment function keys.
3. Press **F3** (Assign) to display the Assign screen.

The system responds with the Assign screen as shown in Figure A-15.

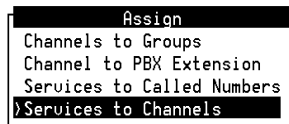

Figure A-15. Assign Screen

4. Select **S**ervices to Channels from the Assign screen.
5. Press **ENTER** to display the Services to Channels screen.
6. Press **F2** (Choices) to display all possible services.

The possible services include that may be assigned directly to the channel include:

- *DNIS_SVC: allows the system to apply the service definitions entered under the Assign Service to Called Number screen
 - AUDIX+ldg: allows callers access to either the INTUITY AUDIX application or the INTUITY Lodging application based upon the identity of the phone from which they are calling
 - AUDIX: allows designated called number accesses the INTUITY AUDIX application.
 - ldg_ni_ca: allows callers to leave a message for any guest after entering the guest's extension number.
 - ldg_ni_vm: allows guests to retrieve messages from any phone after entering an extension number
 - lodging: provides lodging voice mail and call answer services without entering the extension number
7. Highlight the service. Use the up and/or down arrow keys to move the highlight bar.
 8. Press **ENTER** with your selection highlighted.
 9. Enter **channel number** for the selected service.

⇒ NOTE:

Do not enter the numbers of channels that have not been purchased, or the system will generate alarms.

⇒ NOTE:

If you are assigning the same service to all of the channels, you may enter **all** to assign the same service to all of the channel numbers at one time. You may also enter a range of channels. You do not need to enter the service and the associated channel individually if the same service will be assigned to more than 1 channel.

10. Press **F3** (Save).

The system responds with a Command Output screen verifying that the designated channels are assigned the specified service.
11. Press **F6** (Cancel) to return to the Assign Service to Voice Channels screen.
12. Repeat Step 6 through Step 11 for each channel that needs to be assigned. When you have assigned services to the voice channels, continue with the next step.

13. Press **F6** (Cancel) four times reach the INTUITY Administration menu.
14. Continue with Chapter 2, "Conversion Instructions," Task 10, "Administer the Lucent INTUITY System for Operation with the MERLIN LEGEND," Step 3, page 2-32.

Using the Change Extensions Command

B

Overview

Use the Change Extensions screen to move a series of extension numbers from one block of numbers to another instead of changing each number individually. You can use this screen to move as little as one extension from one number to another. Or, you can use it for a much bigger job: perhaps to change the length of every extension number in your system from four digits to five.

 **CAUTION:**

If you have to change the length of the local extensions, you must first do so at the platform level. Use the platform's Switch Interface Administration command for this purpose.

*Use the **change machine** command to change extension length on a remote machine.*

If you use this screen to move numbers on the local machine, it will also move all of the covering extensions in the given range of numbers.

 **CAUTION:**

*While this screen will move all covering extensions, It will **not** change references to the local system in networked systems,*

If the system to be changed is networked to other AUDIX systems, you must also change the subject entries in all of the connected systems. Since ports on the system with local subscribers whose extensions are to be changed will be disabled while you make the necessary changes, plan to make the changes during a period of very low traffic.

⚠ CAUTION:

*This screen does **not** change the numbers entered into automated attendants. Where any auto-attendant calls a number changed by using this screen, you must separately change that number.*

⚠ CAUTION:

This is a powerful screen. It is safe to use only if you have planned in advance exactly what you need to have it do.

Busyout the Voice Ports

Busyout the voice ports as follows:

1. Starting at the INTUITY Administration screen, select:

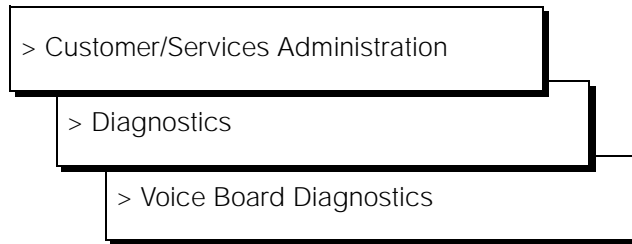

The system responds with the Diagnose Voice Equipment screen, as shown in Figure B-1.

Diagnose Voice Equipment							
CHN	CD.PT	STATE	STATE-CHNG-TIME	SERVICE-NAME	PHONE	GROUP	TYPE
0	0.0	Manoos	Nov 23 09:57:15	-	1111	-	IUC6
1	0.1	Manoos	Nov 23 09:57:18	-	2011	-	IUC6
2	0.2	Manoos	Nov 23 09:57:20	-	2012	-	IUC6
3	0.3	Manoos	Nov 23 10:10:49	-	2014	-	IUC6
4	0.4	Manoos	Nov 23 10:10:52	-	2018	-	IUC6
5	0.5	Manoos	Nov 23 10:10:54	-	2020	-	IUC6

Figure B-1. Diagnose Voice Equipment Screen

2. Press **F8** (Change Keys) to display the diagnose function keys.
3. Press **F2** (Busy-out).

The system responds with the Busyout of Voice Equipment screen (Figure B-2).

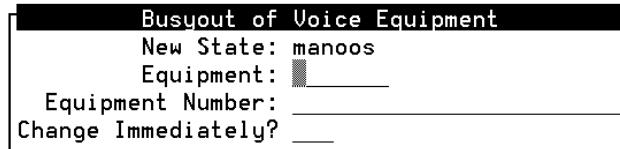

```
Busyout of Voice Equipment
New State: manoos
Equipment: █
Equipment Number: _____
Change Immediately? ____
```

Figure B-2. Busyout of Voice Equipment

4. Complete the following fields:
 - **Equipment:** Enter **ca**
 - **Equipment number:** Enter the range of **0 – the number of the last card**
 - **Change Immediately?:** Enter **yes**
5. Press **F3** (Save).

The system displays a Command Output screen.
6. Press **F6** (Cancel).

The displays the Diagnose Voice Equipment screen.
7. Press **F6** (Cancel) twice to return to the Customer/Services Administration screen.
8. Determine your next step:
 - If the system is networked, continue with "Busyout the Networking Ports".
 - If the system is not networked, continue with "Stop the Voice System," page B-5.

Busyout the Networking Ports

Busyout the networking ports as follows:

1. Starting at the Customer/Services Administration menu, select:

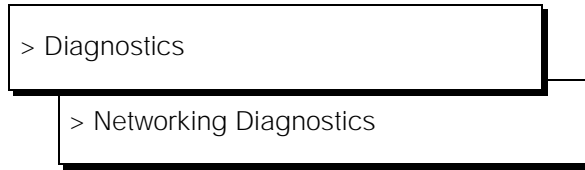

2. Press **F8** (Change Keys) to access the second set of function keys.
3. Press **F2** (Busy-out). After you press the key, the Busyout Networking Channel screen displays (Figure B-3).

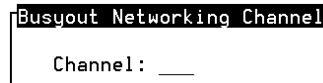

Figure B-3. Busyout Networking Channel Screen

4. Enter the number of the channel you need to busyout.
After you enter the number, the message *working...* displays in the upper right-hand corner of the screen. When the process completes, the *status* field on the Networking Diagnostics screen updates and shows *busyout* for the channel you entered.
5. Repeat steps 3 through 4 for each channel you need to busyout.
6. When you finish busying out channels, press **F6** (Cancel) three times to exit the screen and return to the Lucent INTUITY Administration menu.
7. Continue with "Stop the Voice System".

Stop the Voice System

The following procedure describes how to stop the Lucent INTUITY voice system.

1. Starting at the Lucent INTUITY Administration menu, select:

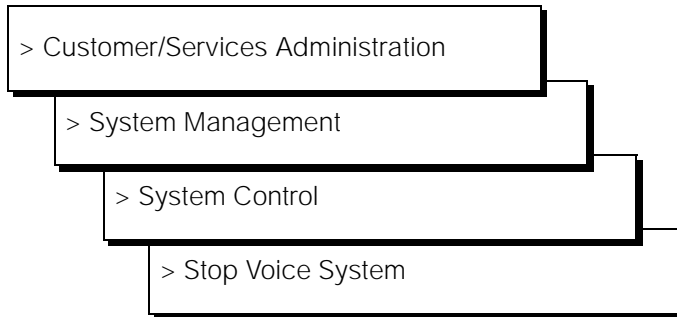

The system displays the following prompt:

Enter y to continue, n to quit.

2. Enter **y**

The system stops the voice system and returns to the System Control screen. If the system displays the following message:

**The Voice System has stopped.
Press ENTER to continue.**

press **ENTER** to return to the System Control screen.

3. Press **F6** (Cancel) three times to return to the Lucent INTUITY Administration menu.
4. Determine your next step:
 - If you want to change the length of local extension numbers, continue with "Changing a Block of Extensions (with Extension Length Change)".
 - If you want to change a block of extensions, continue with "Changing a Block of Extensions (without Extension Length Change)" on page B-9".

Changing a Block of Extensions (with Extension Length Change)

Change the length of local extension numbers as follows:

1. Choose *Switch Interface Administration* from the Lucent INTUITY Administration menu and change the entry in the Extension Length field to reflect the new extension length.
2. From the Lucent INTUITY Administration menu, select AUDIX Administration. At the command line enter **change machine machine_name**.

Note the ranges of extension numbers as they are before modification. (If you have a system printer, enter **print display machine** to get a copy before you enter **change machine**.)

3. When updating remote machines, correct the `Extension Length` field.
4. Re-enter the prefixes, and the start and end extensions as they will be when the conversion is completed.
5. At the `enter command:` prompt, enter either:

Full Command Version

change extensions

Short Command Version

ch e

The system displays the Change Extensions screen (Figure B-4):

```
AUDIX           Active           Alarms:  wA           Logins:  2
change extensions                                     Page 1 of 1

                                CHANGE EXTENSIONS

                                Machine Name:  columbus

Change extensions beginning with:  9900           Ending with:  9999
To new extension beginning with:  29900         Ending with:

                                PROGRESS REPORT

                                Changed extensions from:           through:
                                                to:           through:
                                Number of extensions changed:  0

                                Changing covering extensions?
                                Number of changed covering extensions:  0

Be sure ALL voice and network ports are Out of Service before continuing!
enter command: change extensions
```

Figure B-4. Change Extension Screen

6. Enter the *name of the AUDIX machine* for which you are changing extension numbers.
7. Enter the *boundries of the extension numbers* you are changing, that is, enter two numbers: the beginning (smallest affected) extension number. and the ending (largest affected) extension number. (In the example, the 100 extensions to be changed are those currently numbered between 9900 and 9999.)
8. Enter the *new beginning extension number*.

Here you enter the *beginning number of the new block of numbers* to which the extensions named in the preceding step are to be changed. (In the example, extension number 9900 is to be changed to 29900, and numbers up through 9999 are to be changed to corresponding numbers above 29900. For example, an extension 9947 becomes extension 29947.)

All other fields are display fields.
9. Press **(F3)** (Enter) to initiate the process.

The system fills in the **Ending With** field and asks you to confirm your intent.

If the system fills in the `Ending With` field and prints "Subscriber Already Exists," you have specified a range of numbers that includes at least one number that is already assigned. The system will not permit the Change Extensions screen to delete an existing number in the course of adding another. In this case, continue through the lettered steps below:

- a. Access `CANCEL` to exit this screen.
 - b. Type **list address ranges** at the command line. Discover from the resulting list where to find extensions within the range you earlier specified to receive the extensions being changed.
 - c. Having determined in the previous step which machine(s) have the problem extensions assigned, either type **list extension** if the machine is local, or type **list remote-extensions** *<remote machine name>* if the machine is remote.
 - d. Use this information as a basis to reconsider the target range of numbers. Once you have worked out new number ranges, return to step 1 of this procedure to implement them.
10. Press `F3` (Enter) again.

The system fills in the display fields as it works and displays the message `Command Successfully Completed` when finished. The cursor returns to the command line.

 **NOTE:**

If for some reason you have to press `CANCEL` during this operation, a certain amount of work will already have been done by the program. Recover as follows:

- a. Note the numbers shown in the display fields. They will indicate approximately where the program stopped working.
 - b. Next, list extensions to find exactly which numbers have been changed and which have not. (Use the **print list e** command to make a copy on your system printer.)
 - c. Finally, plan what needs to be done to recover, and use the **ch e** command to change extension numbers as necessary.
11. Type `exit` to leave AUDIX Administration.
12. While the local machine is busied out, connect, in turn, to each remote machine with which the local machine is networked. On each remote machine, perform steps 2 through 11 using the name of the original local machine in fields that call for a machine name.

 **CAUTION:**

*The network ports of the machine on which the local subscriber's extension length has been changed **must** remain busied out until the change has been administered on all remote systems.*

13. Determine your next step:
 - If you need to change a block of extension numbers without changing the extension length, continue with "Changing a Block of Extensions (without Extension Length Change).
 - If you are finished changing extensions, continue with "Release the Voice Ports," page B-5.

Changing a Block of Extensions (without Extension Length Change)

Change a block of extensions from one series of numbers to another as follows:

1. Read the precautions that are given starting on page B-1.
2. For each system (remote or local) that needs to have a new range defined to accommodate the intended new block of extensions do the following.

Access the AUDIX **change machine *name*** screen and define an address range that includes the new block of extensions.

⇒ NOTE:

Be sure to perform this step first. If all machines are prepared for the change, service across the network will be little affected.

3. From the Lucent INTUITY Administration menu, select AUDIX Administration.
4. At the `enter command:` prompt, enter either:

Full Command Version

change extensions

Short Command Version

ch e

The system displays the Change Extensions screen (Figure B-5):

```
AUDIX           Active           Alarms:  wA           Logins:  2
change extensions                                     Page 1 of 1

                                CHANGE EXTENSIONS

                                Machine Name:  columbus

Change extensions beginning with:  9900           Ending with:  9999
To new extension beginning with:  29900         Ending with:

                                PROGRESS REPORT

                                Changed extensions from:           through:
                                                to:                       through:
                                Number of extensions changed:  0

                                Changing covering extensions?
                                Number of changed covering extensions:  0

Be sure ALL voice and network ports are Out of Service before continuing!
enter command: change extensions
```

Figure B-5. Change Extension Screen

5. Enter the *name of the AUDIX machine* for which you are changing *local* subscriber's extension numbers. This is the only system on which this procedure will be performed.
6. Enter the *boundries of the extension numbers* you are moving, that is, enter two numbers: the beginning (smallest affected) extension number, and the ending (largest affected) extension number. (In the example, the 100 extensions to be moved are those currently numbered between 29900 and 29999.)
7. Enter the *new beginning extension number*.

Here you enter the *beginning number of the new block of numbers* to which the extensions named in the preceding step are to be moved. (In the example, extension number 29900 is to be changed to 29600, and numbers up through 29999 are to be changed to corresponding numbers above 29600. For example, an extension 29947 becomes extension 29647.)

All other fields are display fields.
8. Press **(F3)** (Enter) to initiate the process.

If the system fills in the `Ending with` field and asks you to confirm your intent, continue with Step 9.

If the system fills in the `Ending With` field and prints "Subscriber Already Exists," you have specified a range of numbers that includes at least one number that is already assigned. The system will not permit the Change Extensions screen to delete an existing number in the course of adding another. In this case, continue through the lettered steps below:

- a. Access `CANCEL` to exit this screen.
 - b. Type **list address ranges** at the command line. Discover from the resulting list where to find extensions within the range you earlier specified to receive the extensions being changed.
 - c. Having determined in the previous step which machine(s) have the problem extensions assigned, either type **list extension** if the machine is local, or type **list remote-extension** *<remote machine name>* if the machine is remote.
 - d. Use this information as a basis to reconsider the target range of numbers. Once you have worked out new number ranges, return to step 1 of this procedure to implement them.
9. Press `F3` (Enter) again.

The system fills in the display fields as it works and displays the message `Command Successfully Completed` when finished. The cursor returns to the command line.

⇒ NOTE:

If for some reason you have to press `CANCEL` during this operation, a certain amount of work will already have been done by the program. Recover as follows:

- a. Note the numbers shown in the display fields. They will indicate approximately where the program stopped working.
 - b. Next, list extensions to find exactly which numbers have been changed and which have not. (Use the **print list e** command to make a copy on your system printer.)
 - c. Finally, plan what needs to be done to recover, and use the **ch e** command to change extension numbers as necessary.
10. Continue with "Release the Voice Ports".

⇒ NOTE:

If a remote system is not administered to receive automatic updates, extension changes will need to be done manually on this system.

Release the Voice Ports

Release the voice ports as follows:

1. Starting at the Lucent INTUITY Administration menu, select:

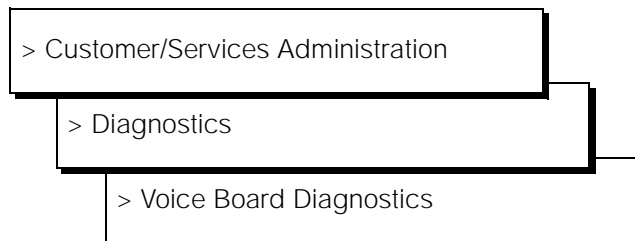

The system responds with the Diagnose Voice Equipment screen, as shown in Figure B-6.

⇒ NOTE:

Ports will be in the manually-out-of-service (Manoos) state if you are installing a new card or if the ports are busied out. These will transition to in-service (Inserv) when they are released if the port detects loop current. If released ports transition to or remain facility-out-of-service, the ports are not detecting any loop current.

Diagnose Voice Equipment							
CHN	CD.PT	STATE	STATE-CHNG-TIME	SERVICE-NAME	PHONE	GROUP	TYPE
0	0.0	Manoos	Nov 23 09:57:15	-	1111	-	IUC6
1	0.1	Manoos	Nov 23 09:57:18	-	2011	-	IUC6
2	0.2	Manoos	Nov 23 09:57:20	-	2012	-	IUC6
3	0.3	Manoos	Nov 23 10:10:49	-	2014	-	IUC6
4	0.4	Manoos	Nov 23 10:10:52	-	2018	-	IUC6
5	0.5	Manoos	Nov 23 10:10:54	-	2020	-	IUC6

Figure B-6. Diagnose Voice Equipment Screen

2. Press **F8** (Change Keys) to display the diagnose function keys.
3. Press **F3** (Release) to display the screen showing the Release of Voice Equipment screen.

The system responds with the Release of Voice Equipment screen, as shown in Figure B-7.

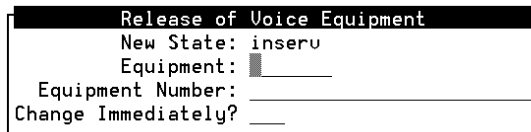

Figure B-7. Release of Voice Equipment Screen

4. Complete the following fields:
 - Equipment: Enter **ca**
 - Equipment number: Enter the range of **0 – the number of the last card**
 - Change Immediately?: Enter **yes**
5. Press **F3** (Save).

The system displays a Command Output screen.
6. Press **F6** (Cancel).

The displays the Diagnose Voice Equipment screen.
7. Press **F6** (Cancel) three times to return to the Lucent INTUITY Administration menu.
8. Determine your next step:
 - If the system is networked, continue with "Release the Networking Ports".
 - If the system is not networked, determine your next step:
 - If the system has the Call Accounting System (CAS) software, continue with Chapter 2, "Conversion Instructions," Task 15, "Change the CAS Switch Assignment," page 2-36.
 - If the system does not have CAS, continue with Chapter 2, "Conversion Instructions," Task 16, "Clear any Alarms," page 2-37.

Release the Networking Ports

Release the networking ports as follows:

1. Begin at the Lucent INTUITY Administration menu, and select:

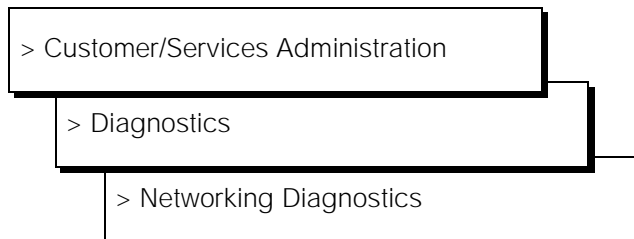

2. Press **F8** (Change Keys) to access the second set of function keys.
3. Press **F3** (Release). After you press the key, you see the Release Networking Channel screen as shown in Figure B-8.



Figure B-8. Release Networking Channel Screen

4. Enter the number of the channel you need to release.
After you enter the number, you see the message *working...* in the upper right-hand corner of the screen. When the process completes, the Status field on the Networking Diagnostics screen updates and shows *idle* for the channel you entered.
5. Repeat steps 3 through 5 for each channel you need to release.
6. When you finish releasing channels, press **F6** (Cancel) to exit the screen and return to the Lucent INTUITY Administration menu.
7. Determine your next step:
 - If the system has the Call Accounting System (CAS) software, continue with Chapter 2, "Conversion Instructions," Task 15, "Change the CAS Switch Assignment," page 2-36.
 - If the system does not have CAS, continue with Chapter 2, "Conversion Instructions," Task 16, "Clear any Alarms," page 2-37.

